

 MADE IN  
AUSTRIA

 **VOERE**  
JAGD- UND SPORTWAFFEN

**2022**

**JAGDGEWEHRE  
SPORTGEWEHRE  
SCHALLDÄMPFER  
WAFFENZUBEHÖR**

**UMAREX**  
A U S T R I A

[www.umarex.at](http://www.umarex.at)



**VOERE**

**WHEN PRECISION MATTERS**

[www.voere-shop.com](http://www.voere-shop.com)



## ÖSTERREICHISCHE TRADITION SEIT 1965

### AUSTRIAN TRADITION SINCE 1965

Wir blicken auf eine über 50-jährige Geschichte mit zahlreichen innovativen Entwicklungen zurück. Unser Innovationsgeist ist seit vielen Jahren ungebrochen und wir versuchen stets neue Wege zu gehen.

*We look back on a long history of more than 50 years with many innovative developments. Our spirit of innovation has been unbroken for many years and we are always trying to break new grounds.*



**VOERE K15A** (2015)

*Leichte Kleinkaliber Repetierbüchse "Survival Gewehr"  
Light weight Rimfire Bolt Action Rifle "Survival Rifle"*



**VOERE LBW** (2003)

*Luxus Jagdgewehre (Take-Down System)  
Luxus hunting rifles with (Take-Down system)*



**VOERE VICTOR 3** (2021)

*Sportbüchse kompatibel mit Remington 700® SA und AICS Magazinen  
Bolt Action rifle compatible with Remington 700 SA® und AICS magazines*



**VOERE X4/X5** (2018)

*Modulare Präzisionsgewehre - komplett beidseitig verwendbar  
Modular precision rifles - completely ambidextrous design*

## 6 JAGDLICHES SCHIESSEN | HUNTING SHOOTING

- 8 VOERE **LBW Standard** (Jagd Repetierbüchse | *Hunting Bolt Action Rifle*)
- 10 VOERE **LBW Luxus / Deluxe** (Luxus Repetierbüchse | *Deluxe Bolt Action Rifle*)
- 12 VOERE **LBW Take Down** (Luxus Repetierbüchse | *Deluxe Bolt Action Rifle*)
- 13 VOERE **LBW Stutzen / Full Stock** (Luxus Repetierbüchse | *Deluxe Bolt Action Rifle*)
- 14 VOERE **LBW-M** (Universelle Repetierbüchse | *Universal Bolt Action Rifle*)
- 16 VOERE **S16** (Leichte Schonzeit Repetierbüchse | *Light Weight Bolt Action Rifle*)
- 18 VOERE **Tirolerin** (Luxus Take Down Repetierbüchse | *Deluxe Take Down Bolt Action Rifle*)
- 20 VOERE **2155** (K98 Repetierbüchse | *M98 Bolt Action Rifle*)
- 22 VOERE **2165** (K98 Luxus Repetierbüchse | *M98 Deluxe Bolt Action Rifle*)

## 26 TAKTISCHES SCHIESSEN | TACTICAL SHOTING

- 30 VOERE **M2** (223 Rem. - 300 Win. Mag.)
- 36 VOERE **X3** (6,5x47 Lapua - 408 CT)
- 40 VOERE **X4** (300 Norma Mag. - 408 CT)
- 42 VOERE **X5** (416 Barrett - 50 Browning)

## 46 DYNAMISCHES SCHIESSEN | DYNAMIC SHOOTING

- 48 VOERE **VICTOR 3** (Standard Sportbüchse | *Standard Sport Bolt Action Rifle*)
- 50 VOERE **ALPHA 3** (Universelle Sportbüchse | *Universal Sport Bolt Action Rifle*)

## 52 SPORTLICHES SCHIESSEN | SPORT SHOOTING

- 54 VOERE **LBW Light-Varmint** (Sport Repetierbüchse | *Sport Bolt Action Rifle*)
- 56 VOERE **LBW Heavy-Varmint** (Varmint Repetierbüchse | *Varmint Bolt Action Rifle*)
- 58 VOERE **LBW Match-Varmint** (Match Repetierbüchse | *Match Bolt Action Rifle*)

## 60 KLEINKALIBER SCHIESSEN | RIMFIRE SHOOTING

- 62 VOERE **K15A** (Leichte Kleinkaliber Repetierbüchse | *Light Weight Rimfire Bolt Action Rifle*)
- 64 VOERE **Tirolerin - Rimfire** (Luxus Kleinkaliber Repetierbüchse | *Deluxe Rimfire Bolt Action Rifle*)
- 66 VOERE **VICTOR 3 - Rimfire** (Sport Kleinkaliber Repetierbüchse | *Sport Rimfire Bolt Action Rifle*)

## 68 SCHALLDÄMPFER | SUPPRESSORS

- 72 VOERE **End-Barrel Schalldämpfer** | *VOERE End-Barrel Suppressors*
- 79 VOERE **Pistolen Schalldämpfer** | *VOERE Pistol Suppressor*
- 80 VOERE **Over-Barrel Schalldämpfer** | *VOERE Over-Barrel Suppressors*
- 82 VOERE **Integral Over-Barrel Schalldämpfer** | *VOERE Integral Over-Barrel Suppressors*
- 84 VOERE **Integral Schalldämpfer** | *VOERE Integral Suppressors*
- 86 VOERE **PET-Flaschen Adapter** | *VOERE PET-Bottle Adapter*
- 88 VOERE **Mündungsbremsen** | *VOERE Muzzle Brakes*
- 91 VOERE **Mündungsfeuerdämpfer** | *VOERE Blast Deflector*
- 92 VOERE **Mündungsschutz** | *VOERE Muzzle Protection*

## 94 ZUBEHÖR | ACCESSORY

- 96 K98 Zubehör | *M98 Accessory*
- 98 Picatinny-Schienen, ZF-Montagen | *Picatinny-Rails, Rifle Scope Mounts*
- 108 Zweibeine, Erdsporn | *Bipods, Monopod*
- 110 Abzüge | *Triggers*
- 112 Magazine | *Magazines*
- 116 Wechselläufe | *Interchangeable Barrels*
- 121 Barreled Actions
- 122 Visierungen | *Sights*
- 124 Schäfte | *Stocks*
- 134 Gewehrtaschen | *Rifle Cases*
- 140 Merchandise



VOERE LBW Standard mit Schichtholzschäft multicolour  
VOERE LBW Standard with laminated wood stock multicolour

# Hunting Kit 20-03 „EXCLUSIV“

**LBW Standard, Weaver Schiene 2-tlg., Montageringe 30 mm, Hawke Zielfernrohr Endurance 30 WA SF, 4-16x50, LR Dot (8x), 30 mm IR, VOERE Schalldämpfer Overbarrel. Stecher oder Direktabzug. Kaliberangabe erforderlich!**



**Hunting Kit 20-03 „EXKLUSIV SD“**

**UVP komplett 2.549,- €**



ohne Schalldämpfer

**Hunting Kit 20-03 „EXCLUSIV“**

**UVP komplett 1.999,- €**

**TECHNISCHE DATEN VOERE LBW 20-03:**

Länge: (Mini/Standard) ca. 113 cm  
 Lauflänge: (Mini/Standard) 60 cm, optional 55 cm  
 (Medium/Magnum) 65 cm, optional 60 cm  
 Gewicht: ab 2,9 kg

**KALIBER**

Mini: .222 Rem., .223 Rem.  
 Standard: 6,5x55, 6,5x57, 7x57, 7x64, 8x57IS, 9,3x62, .22-250,  
 .243 Win., .308 Win., .25-06, .270 Win., .30-06  
 Medium: 6,5x63 Messner Mag, 6,5x68, 8x68 S  
 Magnum: 7mm Rem. Mag., 7mm WSM, .270 WSM,  
 .300 Win.Mag., .300 WSM



Seitensicherung



Schaft mit verlaufender deutscher Backe,  
leichter Schweinsrücken



Robuste 3-Warzenverriegelung  
Kaliberwechsel nur 60° Öffnungswinkel

**LBW Luxus, Picatinny Schiene, Montageringe 30 mm, Hawke Zielfernrohr Frontier 30 SF, 2,5-15x50, LR Dot, 30 mm IR, VOERE Schalldämpfer Overbarrel. Stecher oder Direktabzug. Kaliberangabe erforderlich!**



## Hunting Kit 20-03 „PREMIUM SD“

**UVP komplett 3.399,- €**



ohne Schalldämpfer

## Hunting Kit 20-03 „PREMIUM“

**UVP komplett 2.939,- €**

### TECHNISCHE DATEN VOERE LBW 20-03:

Länge: (Mini/Standard) ca. 113 cm  
 Lauflänge: (Mini/Standard) 60 cm, optional 55 cm  
 (Medium/Magnum) 65 cm, optional 60 cm  
 Gewicht: ab 3,2 kg

### KALIBER

Mini: .222 Rem., .223 Rem.  
 Standard: 6,5x55, 6,5x57, 7x57, 7x64, 8x57IS, 9,3x62, .22-250,  
 .243 Win., .308 Win., .25-06, .270 Win., .30-06  
 Medium: 6,5x63 Messner Mag, 6,5x68, 8x68 S  
 Magnum: 7mm Rem. Mag., 7mm WSM, .270 WSM, .300 Win.Mag., .300 WSM



Geräuschloses Handspannsystem mit Kugelschreiberprinzip



Robuste 3-Warzenverriegelung  
 Kaliberwechsel  
 nur 60° Öffnungswinkel



Hochwertiges Nussbaumholz, bay. Backe,  
 Monte Carlo Effekt, Schuppenfischhaut von  
 leichter Ornamentik umschlossen

ALLE VOERE PRODUKTE

**MADE IN AUSTRIA**

# JAGDLICHES SCHIESSEN HUNTING SHOOTING

## JAGDLICHES SCHIESSEN

**VOERE bietet für jeden Jäger/in das perfekte Jagderlebnis!**

Unser umfangreiches Sortiment reicht variantenreichen Repetierbüchsen mit Take Down System bis hin zu traditionellen Büchsen mit K98 Systemen.

Unsere jahrelange Erfahrung spiegelt sich in der ausgereiften Technik und Verlässlichkeit unserer Waffen wieder, was Jäger und Schützen seit vielen Jahren begeistert. Unser besonderes Augenmerk liegt auf der Qualität und Präzision unserer Jagdwaffen.

## HUNTING SHOOTING

*VOERE offers the perfect hunting experience for every hunter!*

*Our large assortment from hunting rifles ranges from a variety of bolt action rifles with Take-Down Actions and traditional rifles with M98 Actions.*

*Our many years of experience is reflected in the perfected technology and reliability of our weapons. Hunters and shooters all around the world are thrilled of our weapons. Particular attention is paid to the quality and precision of our weapons.*

VOERE LBW Standard mit Schichtholzschafft multicolour  
VOERE LBW Standard with laminated wood stock multicolour

## MODELLÜBERSICHT | MODEL OVERVIEW



**Mod. LBW Standard**  
Jagd Repetierbüchse / Hunting Bolt Action Rifle  
ab / from **€ 1.240,40** | Art.Nr.: WA2003-00-0010



**Mod. LBW Luxus / Deluxe**  
Luxus Repetierbüchse / Deluxe Bolt Action Rifle  
ab / from **€ 1.796,40** | Art.Nr.: WA2003-00-0004



**Mod. LBW-M**  
Universelle Repetierbüchse / Universal Bolt Action Rifle  
ab / from **€ 3.693,40** | Art.Nr.: WA2003-00-0015



**Mod. LBW Take Down**  
Luxus Take Down Repetierbüchse / Deluxe Take Down Bolt Action Rifle  
ab / from **€ 2.598,50** | Art.Nr.: WA2003-00-0006



**Mod. LBW Stutzen / Full Stock**  
Universelle Repetierbüchse / Universal Bolt Action Rifle  
ab / from **€ 2.031,70** | Art.Nr.: WA2003-00-0005



VOERE LBW Standard mit Schichtholzschäft multicolour  
VOERE LBW Standard with laminated wood stock multicolour



**Mod. S16**  
Schonzeit Repetierbüchse / Light Weight Bolt Action Rifle  
ab / from **€ 895,70** | Art.Nr.: WA2016-00-(0001-0009)



**Mod. Tirolerin**  
Luxus Take Down Repetierbüchse / Deluxe Take Down Bolt Action Rifle  
ab / from **€ 2.664,50** | Art.Nr.: WA2006-00-0002



**Mod. 2155**  
K98 Repetierbüchse / M98 Bolt Action Rifle  
ab / from **€ 1.197,60** | Art.Nr.: WA2155-00-0001



**Mod. 2165**  
K98 Luxus Repetierbüchse / M98 Deluxe Bolt Action Rifle  
ab / from **€ 1.593,30** | Art.Nr.: WA2165-00-0001



IT`S MODULAR

## Mod. LBW STANDARD - JAGD REPETIERBÜCHSE

Mod. LBW STANDARD - HUNTING BOLT ACTION RIFLE



Mod. LBW Standard											
<b>Länge / Length:</b>	ca. 113 cm (MI / ST) - 118 cm (ME / MG / UM)										
<b>Gewicht / Weight:</b>	ca. 3,2 kg										
<b>Lauf / Barrel:</b>	Jagd Stahllauf mit Visierung / Hunting steel-barrel with sight Lauflänge / Barrel length: 60 cm / 24" (MI / ST)   65 cm / 26" (ME / MG / UM) <b>Option:</b> Jagd Stahl-Karbonlauf / Hunting steel-carbon barrel (Kaliber auf Anfrage / Calibre on request) Varmintläufe (Stahl, Karbon) / Varmint-barrels (steel, carbon) (Kaliber auf Anfrage / Calibre on request)										
<b>Kaliber / Calibre:**</b>	<table border="0"> <tr> <td><b>Mini (MI):</b></td> <td>222 Rem.* / 223 Rem.*</td> </tr> <tr> <td><b>Standard (ST):</b></td> <td>6,5x47 Lapua   6,5x55 SE   6,5x57   7,5x55 Suisse   7x57   7x64*   8x57 IS   9,3x62* 22-250 Rem.   243 Win.   25-06 Rem.   270 Win.*   7mm-08 Rem.   308 Win.*   30-06*</td> </tr> <tr> <td><b>Medium (ME):</b></td> <td>6,5x68   8x68 S</td> </tr> <tr> <td><b>Magnum (MG):</b></td> <td>270 WSM*   7mm WSM.   7mm Rem. Mag.   300 WSM   300 Win. Mag.* 300 Wby. Mag.   338 Win. Mag.   375 H&amp;H Mag.*</td> </tr> <tr> <td><b>Ultramagnum (UM):</b></td> <td>338 Lapua Mag. (+ € 427,70) (Kein Kaliberwechsel möglich! / No calibre change possible!)</td> </tr> </table>	<b>Mini (MI):</b>	222 Rem.* / 223 Rem.*	<b>Standard (ST):</b>	6,5x47 Lapua   6,5x55 SE   6,5x57   7,5x55 Suisse   7x57   7x64*   8x57 IS   9,3x62* 22-250 Rem.   243 Win.   25-06 Rem.   270 Win.*   7mm-08 Rem.   308 Win.*   30-06*	<b>Medium (ME):</b>	6,5x68   8x68 S	<b>Magnum (MG):</b>	270 WSM*   7mm WSM.   7mm Rem. Mag.   300 WSM   300 Win. Mag.* 300 Wby. Mag.   338 Win. Mag.   375 H&H Mag.*	<b>Ultramagnum (UM):</b>	338 Lapua Mag. (+ € 427,70) (Kein Kaliberwechsel möglich! / No calibre change possible!)
<b>Mini (MI):</b>	222 Rem.* / 223 Rem.*										
<b>Standard (ST):</b>	6,5x47 Lapua   6,5x55 SE   6,5x57   7,5x55 Suisse   7x57   7x64*   8x57 IS   9,3x62* 22-250 Rem.   243 Win.   25-06 Rem.   270 Win.*   7mm-08 Rem.   308 Win.*   30-06*										
<b>Medium (ME):</b>	6,5x68   8x68 S										
<b>Magnum (MG):</b>	270 WSM*   7mm WSM.   7mm Rem. Mag.   300 WSM   300 Win. Mag.* 300 Wby. Mag.   338 Win. Mag.   375 H&H Mag.*										
<b>Ultramagnum (UM):</b>	338 Lapua Mag. (+ € 427,70) (Kein Kaliberwechsel möglich! / No calibre change possible!)										
<b>Magazin / Magazine:</b>	Stahlmagazin 2/3-Schuss / Steel magazine 2/3-rounds <b>Option:</b> Stahlmagazin 4/5-Schuss / Steel magazine 4/5-rounds										
<b>Abzug / Trigger:</b>	Direktabzug (MF) / Direct trigger <b>Option:</b> Rückstecher (RST) / Single-set trigger										
<b>Sicherung / Safety:</b>	Seitliche Sicherung (Abzugssicherung) / Side safety (trigger safety)										
<b>Schaft / Stock:</b>	Walnussholzschäft, geölt (Rechts- oder Linksschütze) / Walnut stock, oiled (right- or left handed shooter) <b>Option:</b> Schichtholzschäfte / Laminated wood stocks										

\* Läufe besitzen bereits ein Gewinde am Lauf (M14x1 / Länge: 15 mm) / Barrels already have a thread on the barrel (M14x1 / length: 15 mm)  
 \*\* Andere Kaliber, Speziallängen und Drallängen möglich. / Other calibres, special lengths and twist rates are possible.  
 Art.Nr.: WA2003-00-0010



IT`S MODULAR

## Mod. LBW LUXUS - LUXUS REPETIERBÜCHSE

Mod. LBW DELUXE - DELUXE BOLT ACTION RIFLE

ab / from  
€ 1.796,40



Handspanner, 3-Stellungssicherung oder Kolbenhalssicherung  
Hand cocking or 3-position safety or Top tang safety

Walnussholzschäft auch als Linksschäft verfügbar!  
Walnut stock also available as stock for left handed shooters.



VOERE LBW Luxus mit Walnussholzschäft, geölt  
VOERE LBW Deluxe with walnut stock, oiled

Lauf-, Kaliber-, Verschlusskopf und Schäftwechsel  
Barrel-, calibre-, bolt head- and stock interchangeable



**Walnussholzschäft, Standard**  
Walnut stock, Standard  
ab / from € 1.743,40

**Schichtholzschäft, braun**  
Laminated wood stock, brown  
ab / from € 1.796,40

**Emboss olive**  
ab / from € 1.743,40

**Walnussholzschäft, Upgrade**  
Walnut stock, Upgrade  
ab / from € 2.095,80

### Mod. LBW Luxus / Deluxe

<b>Länge / Length:</b>	ca. 113 cm (MI / ST) - 118 cm (ME / MG / UM)										
<b>Gewicht / Weight:</b>	ca. 3,3 kg										
<b>Lauf / Barrel:</b>	Jagd Stahllauf mit Visierung / Hunting steel-barrel with sight Lauflänge / Barrel length: 60 cm / 24" (MI / ST)   65 cm / 26" (ME / MG / UM) <b>Option:</b> Jagd Stahl-Karbonlauf / Hunting steel-carbon barrel (Kaliber auf Anfrage / Calibre on request) Varmintläufe (Stahl, Karbon) / Varmint-barrels (steel, carbon) (Kaliber auf Anfrage / Calibre on request)										
<b>Kaliber / Calibre:**</b>	<table border="0"> <tr> <td><b>Mini (MI):</b></td> <td>222 Rem.* / 223 Rem.*</td> </tr> <tr> <td><b>Standard (ST):</b></td> <td>6,5x47 Lapua   6,5x55 SE   6,5x57   7,5x55 Suisse   7x57   7x64*   8x57 IS   9,3x62* 22-250 Rem.   243 Win.   25-06 Rem.   270 Win.*   7mm-08 Rem.   308 Win.*   30-06*</td> </tr> <tr> <td><b>Medium (ME):</b></td> <td>6,5x68   8x68 S</td> </tr> <tr> <td><b>Magnum (MG):</b></td> <td>270 WSM*   7mm WSM.   7mm Rem. Mag.   300 WSM   300 Win. Mag.* 300 Wby. Mag.   338 Win. Mag.   375 H&amp;H Mag.*</td> </tr> <tr> <td><b>Ultramagnum (UM):</b></td> <td>338 Lapua Mag. (+ € 427,70) (Kein Kaliberwechsel möglich! / No calibre change possible!)</td> </tr> </table>	<b>Mini (MI):</b>	222 Rem.* / 223 Rem.*	<b>Standard (ST):</b>	6,5x47 Lapua   6,5x55 SE   6,5x57   7,5x55 Suisse   7x57   7x64*   8x57 IS   9,3x62* 22-250 Rem.   243 Win.   25-06 Rem.   270 Win.*   7mm-08 Rem.   308 Win.*   30-06*	<b>Medium (ME):</b>	6,5x68   8x68 S	<b>Magnum (MG):</b>	270 WSM*   7mm WSM.   7mm Rem. Mag.   300 WSM   300 Win. Mag.* 300 Wby. Mag.   338 Win. Mag.   375 H&H Mag.*	<b>Ultramagnum (UM):</b>	338 Lapua Mag. (+ € 427,70) (Kein Kaliberwechsel möglich! / No calibre change possible!)
<b>Mini (MI):</b>	222 Rem.* / 223 Rem.*										
<b>Standard (ST):</b>	6,5x47 Lapua   6,5x55 SE   6,5x57   7,5x55 Suisse   7x57   7x64*   8x57 IS   9,3x62* 22-250 Rem.   243 Win.   25-06 Rem.   270 Win.*   7mm-08 Rem.   308 Win.*   30-06*										
<b>Medium (ME):</b>	6,5x68   8x68 S										
<b>Magnum (MG):</b>	270 WSM*   7mm WSM.   7mm Rem. Mag.   300 WSM   300 Win. Mag.* 300 Wby. Mag.   338 Win. Mag.   375 H&H Mag.*										
<b>Ultramagnum (UM):</b>	338 Lapua Mag. (+ € 427,70) (Kein Kaliberwechsel möglich! / No calibre change possible!)										
<b>Magazin / Magazine:</b>	Stahlmagazin 2/3-Schuss / Steel magazine 2/3-rounds <b>Option:</b> Stahlmagazin 4/5-Schuss / Steel magazine 4/5-rounds										
<b>Abzug / Trigger:</b>	Direktabzug (MF) / Direct trigger <b>Option:</b> Matchdruckpunkt abzug (MD), Rückstecher (RST) / Two-stage Match trigger, Single-set trigger										
<b>Sicherung / Safety:</b>	Handspanner mit Kammsperre / Manual cocking safety with bolt lock <b>Option:</b> 3 Stellungen-Schlagbolzensicherung / Kolbenhalssicherung (+ € 299,40) 3-position firing pin safety / Top tang safety (+ € 299,40)										
<b>Schäft / Stock:</b>	Walnussholzschäft, geölt (Rechts- oder Linksschütze) / Walnut stock, oiled (right- or left handed shooter) <b>Option:</b> Walnussholzschäft, Upgrade / Schichtholzschäfte Walnut stock, Upgrade / Laminated wood stocks										

\* Läufe besitzen bereits ein Gewinde am Lauf (M14x1 / Länge: 15 mm) / Barrels already have a thread on the barrel (M14x1 / length: 15 mm)

\*\* Andere Kaliber, Speziallängen und Drallängen möglich. / Other calibres, special lengths and twist rates are possible.

Art.Nr.: WA2003-00-0004



IT`S MODULAR

## Mod. LBW TAKE DOWN - TAKE DOWN REPETIERBÜCHSE

Mod. LBW TAKE DOWN - TAKE DOWN BOLT ACTION RIFLE

VOERE Schnellwechsel-Montage-Basis  
VOERE rifle Quick-Detachable-Mounting-Base

STANDARD

ab / from  
€ 2.598,50



### TAKE DOWN SYSTEM

Schneller Schaftwechsel durch Schnappverschluss!

Quick stock exchange due to snap locks!

Schaftwechsel mit Schnappverschluss  
Quick detachable stock with snap lock

### Mod. LBW Take Down

Innovative  
TAKE-DOWN  
SYSTEM

<b>Länge / Length:</b>	ca. 113 cm (MI / ST) - 118 cm (ME / MG / UM)
<b>Gewicht / Weight:</b>	ca. 3,3 kg
<b>Lauf / Barrel:</b>	Jagd Stahllauf mit Visierung / Hunting steel barrel with sight Lauflänge / Barrel length: 60 cm / 24" (MI / ST)   65 cm / 26" (ME / MG / UM) <b>Option:</b> Jagd Stahl-Karbonlauf / Hunting steel-carbon barrel (Kaliber auf Anfrage / Calibre on request)
<b>Kaliber / Calibre:**</b>	siehe LBW Luxus / see LBW Deluxe
<b>Magazin / Magazine:</b>	Stahlmagazin 2/3-Schuss / Steel magazine 2/3-rounds <b>Option:</b> Stahlmagazin 4/5-Schuss / Steel magazine 4/5-rounds
<b>Abzug / Trigger:</b>	Direktabzug (MF) / Direct trigger <b>Option:</b> Matchdruckpunktabzug (MD), Rückstecher (RST) / Two-stage Match trigger, Single-set trigger
<b>Sicherung / Safety:</b>	Handspanner mit Kammersperre / Manual cocking safety with bolt lock <b>Option:</b> 3 Stellungs-Schlagbolzensicherung / 3-position firing pin safety
<b>Schaft / Stock:</b>	Walnussholzschäft, geölt (Rechts- oder Linksschütze) / Walnut stock, oiled (right- or left handed shooter) <b>Option:</b> Walnussholzschäft - Upgrade, Stutzschäft / Walnut stock - Upgrade, Fullstock

Art.Nr.: WA2003-00-0006

## Mod. LBW STUTZEN - LUXUS REPETIERBÜCHSE

Mod. LBW FULL STOCK - DELUXE BOLT ACTION RIFLE

Kurzer Stahl Jagdlauf mit Visierung  
Short Steel Hunting barrel with sight

ab / from  
€ 2.031,70



Monte Carlo, Doppelfalzbacke  
Monte Carlo, fish-scale chequering

Picatinny-Schielen, Weaver-Basen und Schnellwechsellmontagen  
Picatinny-rails, Weaver-bases and Quick-detachable scope mounts  
**OPTION**

### Mod. LBW Stutzen / Full Stock

Lauflänge  
Barrel length  
52 cm

<b>Länge / Length:</b>	ca. 105 cm
<b>Gewicht / Weight:</b>	ca. 3,2 kg
<b>Lauf / Barrel:</b>	Jagd Stahllauf mit Visierung / Hunting steel barrel with sight Lauflänge / Barrel length: 52 cm / 20"
<b>Kaliber / Calibre:**</b>	siehe LBW Luxus / see LBW Deluxe
<b>Magazin / Magazine:</b>	Stahlmagazin 2/3-Schuss / Steel magazine 2/3-rounds <b>Option:</b> Stahlmagazin 4/5-Schuss / Steel magazine 4/5-rounds
<b>Abzug / Trigger:</b>	Direktabzug (MF) / Direct trigger <b>Option:</b> Matchdruckpunktabzug (MD), Rückstecher (RST) / Two-stage Match trigger, Single-set trigger
<b>Sicherung / Safety:</b>	Handspanner mit Kammersperre / Manual cocking safety with bolt lock <b>Option:</b> 3 Stellungs-Schlagbolzensicherung / 3-position firing pin safety
<b>Schaft / Stock:</b>	Walnussholzschäft, geölt, Stutzschäft Walnut stock, oiled, Fullstock

Art.Nr.: WA2003-00-0005



IT`S MODULAR

## Mod. LBW-M - UNIVERSELLE REPETIERBÜCHSE

Mod. LBW-M - UNIVERSAL BOLT ACTION RIFLE



Stahl Picatinny-Schiene (0 MOA)  
Steel Picatinny-rail (0 MOA)

ab / from  
**€ 3.693,40**

VOERE LBW-M mit VOERE Polymerschaft inkl. Zubehör  
VOERE LBW-M with VOERE polymer stock incl. accessory



VOERE LBW-M mit GRS-Schichtholzschäft  
VOERE LBW-M with GRS-laminated wood stock

Integral Over-Barrel Schalldämpfer (Stahllauf inkl. Dämpfer)  
Integral Over-Barrel Suppressor (Steel barrel inkl. suppressor)

Weaver-Schiene für Zweibeine  
Weaver-rail for bipods  
**STANDARD**



Polymerschaft - Lochschäft  
Polymerstock - thumbhole stock



Polymerschaft - Pistolengriff  
Polymerstock - pistol grip

### Gewicht unter 6 kg!

Gewehr mit Integral Over-Barrel Schalldämpfer  
inkl. Magazin, VOERE Zweibein, VOERE Erdsporn-Mini  
und VOERE Blockmontage

### Weight under 6 kg!

Rifle with Integral Over-Barrel Suppressor  
incl. magazine, VOERE bipod, VOERE Monopod-Mini  
and VOERE blockmount

## Mod. LBW-M

<b>Länge / Length:</b>	ca. 105 cm
<b>Gewicht / Weight:</b>	ca. 4,1 kg - 4,5 kg
<b>Lauf / Barrel:</b>	Stahllauf mit Integral Over-Barrel Schalldämpfer, Lauflänge: 39 cm / 15" Steel barrel with Integral Over-Barrel Suppressor, Barrel length: 39 cm / 15"
<b>Kaliber / Calibre:*</b>	308 Win.
<b>Magazin / Magazine:</b>	Stahlmagazin 4/5-Schuss / Steel magazine 4/5-rounds <b>Option:</b> Stahlmagazin 2/3-Schuss / Steel magazine 2/3-rounds
<b>Abzug / Trigger:</b>	Direktabzug (MF) / Direct trigger <b>Option:</b> Matchdruckpunktabzug (MD), Rückstecher (RST) / Two-stage Match trigger, Single-set trigger
<b>Sicherung / Safety:</b>	Handspanner mit Kammersperre / Manual cocking safety with bolt lock <b>Option:</b> 3 Stellungen-Schlagbolzensicherung / 3-position firing pin safety
<b>Schaft / Stock:</b>	GRS-Schichtholzschäft "SPORTER" / GRS-laminated wood stock "SPORTER" VOERE Polymerschäfte (2 Varianten) / VOERE polymer stocks (2 versions) GGG "REX" laminiertes Expoxidharzschäft / GGS "REX" laminated epoxy resin stock

The ideal  
rifle for every  
hunting  
situation!

\* Andere Kaliber, Speziallängen und Drallängen möglich. / Other calibres, special lengths and twist rates are possible.

Art.Nr.: WA2003-00-0015



## Mod. S16 - SCHONZEIT REPETIERBÜCHSE

Mod. S16 - LIGHT WEIGHT BOLT ACTION RIFLE



ab / from  
**€ 895,70**

Mündungsbremse und mit Mündungsgewinde 1/2"-20 UNF  
Muzzle brake with muzzle thread 1/2"-20 UNF

Magazinschacht passend für alle AR-15 Magazine.  
Magazine port suitable for all AR-15 magazines.



ab / from  
**€ 1.288,50**

**VOERE S16 mit Integral Schalldämpfer (Integral)<sup>2</sup>**  
**VOERE S16 with Integral Suppressor (Integral)**

Art.Nr.: WA2016-00-(0002/0005/0006)



ab / from  
**€ 1.198,-**

**VOERE S16 Sport mit Stahllauf<sup>3</sup>**  
**VOERE S16 Sport with steel barrel**

Art.Nr.: WA2016-00-(0007/0008/0009)

Aluminium Picatinny-Schiene (0 MOA)  
Aluminium Picatinny-rail (0 MOA)

Höhen- und längenverstellbarer Schaft  
Length- and height adjustable stock

Matchdruckpunktanzug (MD)  
Two-Stage match trigger (MD)

Finger-Stop  
**OPTION | € 20,-**

**VOERE S16 Standard<sup>1</sup>**

(Art.Nr.: WA2016-00-(0001/0003/0004))

### PRODUKTDDETAILS | PRODUCT DETAILS



Schlagbolzensicherung  
Firing pin safety



AR15 Stanag Magazinschacht  
AR15 Stanag magazine well



2-Warzen Verschlusskopf  
2-lug bolt head



Öffnungsspanner Verschluss  
Cock-on-open bolt

Mod. S16						
<b>Länge / Length:</b>	ca. 104 cm (Standard <sup>1</sup> / Sport <sup>3</sup> ) / ca. 100 cm (Integral <sup>2</sup> )					
<b>Gewicht / Weight:</b>	ca. 2 kg (Standard <sup>1</sup> ) / ca. 2,2 kg (Integral <sup>2</sup> / Sport <sup>3</sup> )					
<b>Kaliber / Calibre:<sup>*</sup></b>	<b>Drall / Twist:</b>			<b>Lauf / Barrel:</b>		
	<b>Standard<sup>1</sup></b>	<b>Integral<sup>2</sup></b>	<b>Sport<sup>3</sup></b>	<b>Standard<sup>1</sup></b>	<b>Integral<sup>2</sup></b>	<b>Sport<sup>3</sup></b>
17 Rem.	-	-	1:9"	-	-	50 cm / 20"
222 Rem.	1:10"	1:10"	1:14"	50 cm / 20"	28 cm / 11"	50 cm / 20"
223 Rem.	1:10"	1:10"	1:12"	50 cm / 20"	28 cm / 11"	50 cm / 20"
300 AAC Blackout	1:8"	1:8"	-	50 cm / 20"	28 cm / 11"	-
<b>Magazin / Magazine:</b>	Seitlich angebrachtes 5-Schuss Polymermagazin (AR15) Lateral attached 5-rounds polymer magazine (AR15)					
<b>Abzug / Trigger:</b>	Matchdruckpunktanzug (MD) / Two-stage Match trigger <b>Optional:</b> Finger-Stop					
<b>Sicherung / Safety:</b>	Schlagbolzensicherung / Firing pin safety					
<b>Schaft / Stock:</b>	<b>Beschichtung / Coating: dark grey**</b> Höhen- und längenverstellbarer karbonfaserverstärkter Polymerschaft mit Sandoberfläche Height and length adjustable polymerstock with sand surface					

<sup>\*</sup> Andere Kaliber, Speziallängen und Dralllängen möglich. / Other calibres, special lengths and twist rates are possible.

<sup>\*\*</sup> Andere Beschichtungen auf Anfrage / Other coatings on request



## Mod. TIROLERIN - LUXUS TAKE DOWN REPETIERBÜCHSE

### Mod. TIROLERIN - DELUXE TAKE DOWN BOLT ACTION RIFLE



Doppelfalzbacke (Monte Carlo Effekt)  
Double rabbet cheek piece (Monte Carlo style)

ab / from  
€ 2.664,50

2-Stellungssicherung inkl. Kammersperre  
2-position safety incl. bolt lock

Kombiabzug einstellbar  
Combination trigger adjustable

VOERE Schnellwechsel-Montage-Basis  
Pre-installed VOERE Quick-Detachable-Mounting-Base  
STANDARD

Schaft-, Lauf- und Kaliberwechsel  
Stock-, barrel- and calibre interchangeable

Stahl Jagdlauf mit Edelstahl Mündungsbremse und Gewinde  
Steel hunting barrel with Stainless steel muzzle break and thread

Gewinde / thread = M18x1  
Gewindelänge / thread length = 13 mm

VOERE Tirolerin mit Walnussholzschaft Monte Carlo,  
Schnellwechsel-Montage und Mündungsbremse

VOERE Tirolerin with walnut stock Monte Carlo,  
QD-Mounting-Base and muzzle brake

VOERE Tirolerin mit Walnussholzschaft Schweinsrücken, Picatinny-Schiene,  
Edelstahl Mündungsbremse und Over-Barrel Schalldämpfer

VOERE Tirolerin with walnut stock Hogsback comb, Picatinny-rail,  
Stainless steel muzzle brake and Over-Barrel Suppressor

#### PRODUKTDDETAILS | PRODUCT DETAILS

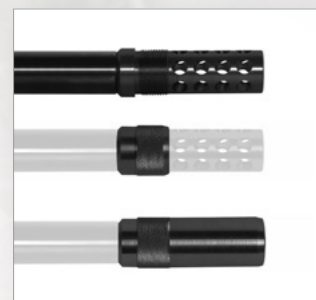

Edelstahl Mündungsbremse  
für SD mit Abdeckhülsen  
Stainless steel muzzle brakes  
for Suppressors with cover caps  
**STANDARD**



2-Stellungs-Schlagbolzensicherung  
inkl. Kammersperre  
2-position firing pin safety  
incl. bolt lock



**Ganzstahlsystem** mit Schaft-,  
Kaliber und Laufwechsel  
Robuste 3-Warzen Verriegelung  
**Steel action** with interchangeable  
stock, calibre and barrel  
Strong 3-lug bolt

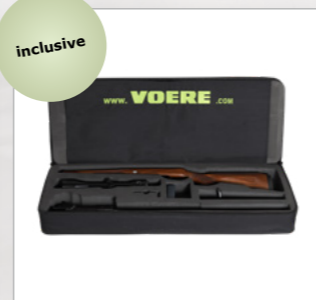

inclusive

Take Down Tasche inkl. Inlay  
Take Down Case incl. Inlay

#### Mod. Tirolerin

<b>Länge / Length:</b>	ca. 110 cm
<b>Gewicht / Weight:</b>	ca. 2,9 kg
<b>Lauf / Barrel:</b>	Stahl Jagdlauf / Steel Hunting barrel Lauflänge / Barrel length: 55 cm / 22"
<b>Kaliber / Calibre:*</b>	6,5x55 SE   6,5x57   7x57   7x64   8x57 IS   9,3x62 22-250 Rem.   243 Win.   25-06 Rem.   270 Win.   308 Win.   30-06 Spring.
<b>Magazin / Magazine:</b>	Zweireihiges Stahlmagazin 3-Schuss / Double-row steel magazine 3-rounds
<b>Abzug / Trigger:</b>	Kombiabzug (Rückstecher / Direktabzug) Combination trigger (Single-set trigger / Direct trigger)
<b>Sicherung / Safety:</b>	2-Stellungs-Schlagbolzensicherung mit Kammersperre / 2-position firing pin safety with bolt lock
<b>Schaft / Stock:</b>	Walnussholzschaft mit Doppelfalzbacke / Walnut stock with double rabbet cheek piece <b>Option:</b> Walnussschaft mit Schweinsrücken / Walnut stock with hogsback comb

\* Andere Kaliber, Speziallängen und Drallängen möglich. / Other calibres, special lengths and twist rates are possible.

Art.Nr.: WA2006-00-0001



## Mod. 2155 - K98 REPETIERBÜCHSE

### Mod. 2155 - M98 BOLT ACTION RIFLE

Walnussschaft mit Schweinsrücken  
Walnut stock with hogsback comb

Org. K98 Flügelsicherung  
Org. M98 Wing-type safety  
**STANDARD**

ab / from  
€ 1.197,60

Jagdliche Schnellwechsel-Montage-Basen  
Hunting Quick-Detachable-Mounting-bases  
**OPTION**



VOERE 2155 mit Walnussholzschafft und Schnellwechsel-Montage  
VOERE 2155 with walnut stock and QD-Mounting-base

Org. Druckpunktanzug (F)  
**OPTION:** Weitere Abzüge

Org. Two-stage trigger (F)  
**OPTION:** Other triggers

VOERE 2165 mit Walnussschaft, Umrüstsatz, Handspanner und Mündungsbremse  
VOERE 2165 with walnut stock, magazine conversion kit, manual cocking safety and muzzle brake

Auch als Linksschaft verfügbar.  
Also available as stock for left handed shooters.

#### SICHERUNGEN | SAFETIES



Standard  
Mod. 2155

Org. Flügelsicherung  
Org. Wing-type safety



ab / from  
€ 213,90

Handspannung mit / ohne  
Kammersperre

Manual cocking safety  
with / without bolt lock



ab / from  
€ 128,30

Drehflügelsicherung mit / ohne  
Hebelsicherung

3-position safety with / without  
bolt sleeve

### Mod. 2155

Begrenzt  
verfügbar!  
Limited!

<b>Länge / Length:</b>	ca. 114 cm (ST / ME) / 119 cm (MG)
<b>Gewicht / Weight:</b>	ca. 3,3 kg
<b>Lauf / Barrel:</b>	Stahl Jagdlauf / Steel Hunting barrel Lauflänge / Barrel length: 60 cm / 24" (ST / ME) / 65 cm / 26" (MG)
<b>Kaliber / Calibre:*</b>	<b>Standard / Medium:</b> 6,5x57   6,5x68   8x68 S   9,3x64   25-06 Rem. <b>Magnum:</b> 7mm Rem. Mag.   7mm Weath. Mag.   257 Weath. Mag.   300 Win. Mag.
<b>Magazin / Magazine:</b>	Alu-Klappdeckelmagazin / Alu drop box magazine kit <b>Option:</b> Umrüstsatz Stahlmagazinkasten für Einsteckmagazin (2/3-Schuss   4/5-Schuss) Detachable magazine conversion kit (2/3-rounds   4/5-rounds)
<b>Abzug / Trigger:</b>	Org. Druckpunktanzug (F) / Org. Two-stage trigger <b>Option:</b> Deutscher Stecher (ST) / Matchdruckpunktanzug (MD) / Rückstecher (RST) / Direktanzug (MF) Double set trigger, Two-stage Match trigger, Single-set trigger, Direct trigger
<b>Sicherung / Safety:</b>	Org. K98 Flügelsicherung / Org. M98 Wing-type safety <b>Option:</b> Drehflügelsicherung (3-Stellungssicherung) / Handspannung Wing-type safety (3-position safety) / Manual cocking safety
<b>Schaft / Stock:</b>	Walnussholzschafft, geölt (Rechts- oder Linksschütze) / Walnut stock, oiled (right- or left handed shooter) <b>Option:</b> Hogue Kunststoffschafft / Hogue polymer stock

\* Andere Kaliber, Speziallängen und Drallängen möglich. / Other calibres, special lengths and twist rates are possible.

Art.Nr.: WA2155-00-0001



## Mod. 2165 - K98 LUXUS REPETIERBÜCHSE

Mod. 2165 - M98 DELUXE BOLT ACTION RIFLE



### PRODUKTDDETAILS | PRODUCT DETAILS



Aluminium Klappdeckelmagazin  
Aluminium drop box magazine kit  
**STANDARD**



Schuppenfischhaut  
Fish-scale checkering



Kolbenhalssicherung  
Top tang safety  
**STANDARD**



Doppelfalzbacke (Monte Carlo)  
Double groove cheek piece

### Mod. 2165

<b>Länge / Length:</b>	ca. 114 cm ( <b>ST / ME</b> ) / 119 cm ( <b>MG</b> )
<b>Gewicht / Weight:</b>	ca. 3,3 kg
<b>Lauf / Barrel:</b>	Stahl Jagdlauf / Steel Hunting barrel Lauf­länge / Barrel length: 60 cm / 24" ( <b>ST / ME</b> ) / 65 cm / 26" ( <b>MG</b> )
<b>Kaliber / Calibre:*</b>	<b>Standard / Medium:</b> 6,5x57   6,5x68   8x68 S   9,3x64   25-06 Rem. <b>Magnum:</b> 7mm Rem. Mag.   7mm Weath. Mag.   257 Weath. Mag.   300 Win. Mag.
<b>Magazin / Magazine:</b>	Alu-Klappdeckelmagazin / Alu drop box magazine kit <b>Optional:</b> Umrüstsatz Stahlmagazinkasten für Einsteckmagazin (2/3-Schuss   4/5-Schuss) Detachable magazine conversion kit (2/3-rounds   4/5-rounds)
<b>Abzug / Trigger:</b>	Org. Druckpunktabzug (F) / Org. Two-stage trigger <b>Optional:</b> Deutscher Stecher (ST), Matchdruckpunkt­abzug (MD), Rückstecher (RST), Direktabzug (MF) Double-set trigger, Two-stage Match trigger, Single-set trigger, Direct trigger
<b>Sicherung / Safety:</b>	Kolbenhalssicherung (Schiebesicherung) / Top tang safety (slide safety) <b>Optional:</b> Drehflügelsicherung (3-Stellungssicherung) / Handspannung Wing-type safety (3-position safety) / Manual cocking safety
<b>Schaft / Stock:</b>	Walnussholzschäft, geölt, Schuppenfischhaut / Walnut stock, oiled, fish-scale checkering

**Begrenzt verfügbar!**  
Limited!

\* Andere Kaliber, Speziallängen und Drallängen möglich. / Other calibres, special lengths and twist rates are possible.

Art.Nr.: WA2165-00-0001

## KALIBERPALETTE | CALIBRE RANGE

KALIBERPALETTE   CALIBRE RANGE					
	Kalibergruppe Calibre group	Dralllängen Twist Rate	Mod. LBW (Standard)	Mod. LBW (Luxus / Take Down)	Mod. LBW-M (Integral Over-Barrel SD)
6,5x47 Lapua	ST	1:8"	15	15	
6,5 Creedmoor	ST	1:8"	15	15	
6,5x55 SE	ST	1:8,5"	5	5	
6,5x57	ST	1:8"	8	8	
6,5x68 S	ME	1:10"	10	10	
7mm - 08 Rem.	ST	1:9,5"	5	5	
7x57	ST	1:8,5"	8	8	
7x64	ST	1:8,5"	13	13	
7mm Rem. Mag.	MG	1:8,5"	10	10	
7mm WSM	MG	1:9,5"	12	12	
7,5x55 Suisse	CH	1:10,5"	5	5	
8x57 IS	ST	1:9,5"	6	6	
8x68 S	ME	1:11"	10	10	
9,3x62	ST	1:14"	7	7	
222 Rem.	MI	1:14"	1	1	
223 Rem.	MI	1:12"	1	1	
25-06 Rem.	ST	1:10"	8	8	
22-250 Rem.	ST	1:14"	2	2	
243 Win.	ST	1:10"	4	4	
270 Win.	ST	1:10"	13	13	
270 WSM	MG	1:10"	12	12	
308 Win.	ST	1:12"	5	5	5
30-06 Spring.	ST	1:10"	8	8	
300 Win. Mag.	MG	1:10"	9	9	
300 Weath. Mag.	MG	1:10"	11	11	
300 WSM	MG	1:10"	12	12	
338 Win. Mag.	MG	1:10"	14	14	
338 Lapua Mag.	UM	1:10"	17	17	
375 H&H Mag.	MG	1:12"	11	11	

1 - 56 Magazinnummern / magazine numbers

## KALIBERPALETTE | CALIBRE RANGE

KALIBERPALETTE   CALIBRE RANGE							
	Kalibergruppe Calibre group	Dralllängen Twist Rate	Mod. S16	Mod. Tirolerin	Mod. 2155	Mod. 2165	*URS K98 / M98
6,5 Creedmoor	ST	1:8"					51
6,5x55 SE	ST	1:8,5"		30			51
6,5x57	ST	1:8"		30	•	•	52
6,5x68	ME	1:10"			•	•	55
7x57	ST	1:8,5"		30			52
7x64	ST	1:8,5"		30			52
7mm Rem. Mag.	MG	1:8,5"			•	•	55
7mm Weath. Mag.	MG	1:10"			•	•	
8x57 IS	ST	1:9,5"		30			53
8x68 S	ME	1:11"					55
9,3x62	ST	1:14"		30			54
9,3x64	ST	1:14"			•	•	
17 Rem.	MI	1:9"	36				
222 Rem.	MI	1:14"	36				
223 Rem.	MI	1:12"	36				
25-06 Rem.	ST	1:10"			•	•	52
22-250 Rem.	ST	1:14"		30	•	•	51
243 Win.	ST	1:10"		30			51
257 Weath. Mag.	MG	1:10"			•	•	
270 Win.	ST	1:10"		30	•	•	52
300 AAC Blackout	MI	1:8"	36				
308 Win.	ST	1:12"		30			51
30-06 Spring.	ST	1:10"		30			52
300 Win. Mag.	MG	1:10"					56

1 - 56 Magazinnummern / magazine numbers

\*URS Umrüstsatz K98 (Magazinnummer) / conversion kit M98 (magazine number)  
• Alu-Klappdeckelmagazin / Alu drop box magazine kit

Andere Kaliber, Speziallängen und Dralllängen möglich. / Other calibres, special lengths and twist rates are possible.

**Bitte beachten Sie, dass die Kaliberauswahl ständigen Änderungen und Erweiterungen unterliegt!**  
Please note, that the calibre list is subject to constant changes and extensions!

# TAKTISCHES SCHIESSEN

## TACTICAL SHOOTING

### VOERE TAKTISCHES SCHIESSEN

Unsere Sportwaffen zeichnen sich durch ihre hohe Präzision und Qualität aus. Schützen schätzen unsere Produkte und setzen unsere Gewehre bei sportlichen Wettbewerben ein, wo sie meist beste Erfolge erzielen. Unsere Gewehre bestehen aus eigens gefertigten Einzelteilen und werden bei uns im Haus entwickelt und produziert.

Des Weiteren zeichnen sich unsere Gewehre durch ihre hohe Modularität aus, wodurch Baugruppen der einzelnen Modelle kombiniert werden können. Dadurch schaffen wir eine einzigartige Austauschbarkeit, welche sonst bei keinen anderen Sportbüchsen möglich ist.

### VOERE TACTICAL SHOOTING

*Our sporting rifles enjoy international reputation and are characterized by their high precision and quality. Shooters appreciate our rifles and use them in international competitions, where they achieve great success. Our sporting rifles are developed and produced in-house with specially manufactured individual parts.*

*Furthermore our rifles are characterized by their high modularity. Individual parts can be combined from the different models. This creates a unique interchangeability, which is not possible by any other tactical rifles.*

VOERE X3 in flat dark earth mit Zubehör  
VOERE X3 in flat dark earth with accessories

MODELLÜBERSICHT | MODEL OVERVIEW

VOERE X-SERIE | VOERE X-SERIES



**Mod. M2**

223 Rem. - 300 Win. Mag.

ab / from € 5.881,30 | Art.Nr.: WA2009-00-0001



**Mod. X3**

6.5x47 Lapua - 408 CT

ab / from € 6.897,20 | Art.Nr.: WA2012-00-0003



**Mod. X4**

300 Norma Mag. - 408 CT

ab / from € 8.597,30 | Art.Nr.: WA2013-00-0001



**Mod. X5**

416 Barrett - 50 Browning

ab / from € 9.538,30 | Art.Nr.: WA2013-00-0002

VOERE X3 in flat dark earth mit Zubehör  
VOERE X3 in flat dark earth with accessories



MODULAR - ROBUST - UPGRADEFÄHIG  
MODULAR - ROBUST - UPGRADEABLE

MODULARER POLYMER HINTERSCHAFT  
MODULAR POLYMER REAR-STOCK

- 1 VOERE Erdsporn Mini / VOERE Monopod Mini € 199,90
- 2 VOERE Blockmontagen / VOERE block mounts € 330,20
- 3 VOERE Schusswinkelkompensator + Halter  
VOERE Angle Cosine Indicator + device € 189,30
- 4 Kahles Zielfernrohr / Kahles rifle scope  
Preis auf Anfrage / Price on request
- 5 VOERE X Zweibein mit Universalaufnahme  
VOERE X bipod mit Universalaufnahme € 320,80
- 6 Aluminium Handschutz  
Aluminium hand guard € 363,60



**Mod. M2**

VOERE M2 multi-colour mit Zubehör und karbonfaserverstärktem Polymer Hinterschaft  
VOERE M2 multi-colour with accessories and carbon fibre reinforced polymer rear-stock

VOERE M2 - POLYMER

ab / from € 4.889,- | Art.Nr.: WA2009-00-0006



**Mod. X3**

VOERE X3 in schwarz mit karbonfaserverstärktem Polymerhinterschaft  
VOERE X3 in black and carbon fibre reinforced polymer rear-stock

VOERE X3 - POLYMER

ab / from € 5.892,- | Art.Nr.: WA2012-00-0004

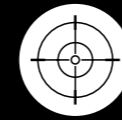

Medium Range  
300 m

Long Range  
1000 m

IT'S MODULAR

## THE MARKSMAN RIFLE FOR HIGHEST DEMANDS

223 Rem. - 300 Win. Mag.



Schusswinkelkompensator mit Universalanbindung  
Angle Cosine Indicator with universal device  
**OPTION | € 189,30**

ab / from  
**€ 5.881**

Sandsackauflage  
Sandbag rest  
**OPTION | € 74,90**

Direktabzug inkl. VOERE Pistolengriff  
Direct trigger incl. VOERE pistol grip  
**STANDARD**

Integrierter Erdsporn  
Integrated monopod

Langer Vorderschaft mit Picatinny-Handschutz  
Long fore-end with Picatinny-handguard  
**OPTION | € 227,70**

VOERE M2 in armor black mit Zubehör  
VOERE M2 in armor black with accessories

Picatinny-Schiene für UIT-Schiene  
Picatinny-rail for UIT-rail  
**OPTION | € 179,60**



Klappschaft rechts / links  
Folding stock right / left



Direktabzug inkl. Winterabzugsbügel  
Direct trigger incl. winter trigger guard



Höhen- und längenverstellbarer Hinterschaft  
Height- and length adjustable rear-stock



VOERE M2 in armor black mit Integral Over-Barrel SD  
VOERE M2 in armor black with Integral Over-Barrel Suppressor

### Mod. M2

<b>Länge / Length:</b>	ca. 114 cm - 129 cm (abhängig von Kaliber und Schaft) / (depending on calibre and stock)		
<b>Gewicht / Weight:</b>	ca. 6,6 kg - 7,4 kg (Gewehr inkl. Magazin und Mündungsbremse) / (rifle incl. magazine and muzzle brake)		
<b>Kaliber / Calibre:**</b>	<b>Drall / Twist:</b>	<b>Lauf / Barrel:**</b>	<b>Magazin / Magazine:</b>
223 Rem.	1:9"	51 cm / 20" / 2,1 kg	5-Schuss / 5-rounds (Stahl-steel)
6,5x47 Lapua	1:8"	66 cm / 26" / 2,5 kg	5-Schuss / 5-rounds (Stahl-steel)
6,5 Creedmoor	1:8"	66 cm / 26" / 2,5 kg	5-/10-Schuss / 5-/10-rounds (Stahl-steel)
6,5x55 SE	1:8,5"	66 cm / 26" / 2,5 kg	5-/10-Schuss / 5-/10-rounds (Stahl-steel)
308 Win.	1:12"	66 cm / 26" / 2,4 kg	5-/10-Schuss / 5-/10-rounds (Stahl-steel)
300 Win. Mag.	1:10"	66 cm / 26" / 2,4 kg	4-Schuss / 4-rounds (Stahl-steel)
<b>Abzug / Trigger:</b>	Direktabzug (MF) / Direct trigger <b>Option:</b> Matchdruckpunktabzug (MD), Rückstecher (RST) / Two-stage Match trigger, Single-set trigger		
<b>Sicherung / Safety:</b>	3 Stellungen-Schlagbolzensicherung / 3-position firing pin safety		
<b>Schaft / Stock:</b>	Taktischer Schaft inkl. Klappschaft, integrierter Erdsporn <b>Option:</b> diverse Vorder- und Hinterschäfte, Fixschaft Tactical stock incl. folding stock, integrated monopod <b>Option:</b> various front- and rear-stocks, fixed stock		

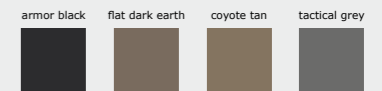

\* Andere Kaliber, Speziallängen, Drallängen und Beschichtungen sind möglich. / Other calibres, special lengths, twist rates and coatings are possible.

Art.Nr.: WA2009-00-0004

\*\* Gewichte exkl. VOERE Match Mündungsbremse (ca. 300g) / Weights excl. VOERE Match muzzle brake (ca. 300g)

Wir behalten uns das Recht vor, technische Abweichungen von Produkten vorzunehmen. Gewichte und Maßnahmen sind nur Richtwerte. We reserve the right to implement technical variations on products. Weights and measures are only approximate values.

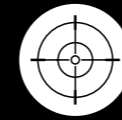

Medium Range  
300 m

Long Range  
1000 m

IT'S MODULAR

## THE MARKSMAN RIFLE FOR HIGHEST DEMANDS

223 Rem. - 300 Win. Mag.



Kahles Zielfernrohr auf Anfrage  
Kahles rifle scope on request

ab / from  
€ 4.895,-

Picatinny Aluminium Handschutz  
Picatinny aluminium hand guard  
**OPTION | € 363,60**

Zweibein-Adapter (Standard Handschutz)  
Bipod-Adapter (Standard hand guard)  
**OPTION | € 53,50**

End-Barrel Schalldämpfer SPORT | End-Barrel TARGET Suppressor



€ 339,20

Ideal für Kaliber bis 7,62  
Ideal for calibre up to 7,62



€ 565,30

Ideal für Kaliber ab 7,62  
Ideal for calibre from 7,62

VOERE M2 in multicolour mit Zubehör  
VOERE M2 in multicolour with accessories

Kammergriff Verlängerung  
Bolt handle extension  
**OPTION | € 13,-**

Karbonfaserverstärkter Polymer Hinterschaft (Lochschaft / Pistolengriff)  
Carbon fibre reinforced polymer rear-stock (thumbhole stock / pistol grip)

Multi-colour Beschichtungen auf Kundenwunsch möglich!  
Multi-colour coatings are possible on customer requirements!

### Mod. M2 - POLYMER

<b>Länge / Length:</b>	ca. 114 cm - 129 cm (abhängig von Kaliber und Schaft) / (depending on calibre and stock)		
<b>Gewicht / Weight:</b>	ca. 6,6 kg - 7,4 kg (Gewehr inkl. Magazin und Mündungsbremse) / (rifle incl. magazine and muzzle brake)		
<b>Kaliber / Calibre:**</b>	<b>Drall / Twist:</b>	<b>Lauf / Barrel:**</b>	<b>Magazin / Magazine:</b>
223 Rem.	1:9"	51 cm / 20" / 2,1 kg	5-Schuss / 5-rounds (Stahl-steel)
6,5x47 Lapua	1:8"	66 cm / 26" / 2,5 kg	5-Schuss / 5-rounds (Stahl-steel)
6,5 Creedmoor	1:8"	66 cm / 26" / 2,5 kg	5-/10-Schuss / 5-/10-rounds (Stahl-steel)
6,5x55 SE	1:8,5"	66 cm / 26" / 2,5 kg	5-/10-Schuss / 5-/10-rounds (Stahl-steel)
308 Win.	1:12"	66 cm / 26" / 2,4 kg	5-/10-Schuss / 5-/10-rounds (Stahl-steel)
300 Win. Mag.	1:10"	66 cm / 26" / 2,4 kg	4-Schuss / 4-rounds (Stahl-steel)
<b>Abzug / Trigger:</b>	Direktabzug (MF) / Direct trigger <b>Option:</b> Matchdruckpunktabzug (MD) / Rückstecher (RST) / Two-stage Match trigger / Single-set trigger		
<b>Sicherung / Safety:</b>	3 Stellungen-Schlagbolzensicherung / 3-position firing pin safety		
<b>Schaft / Stock:</b>	Taktischer Schaft inkl. Klappschaft, integrierter Erdsporn <b>Option:</b> diverse Vorder- und Hinterschäfte Tactical stock incl. folding stock, integrated monopod <b>Option:</b> various front- and rear-stocks		

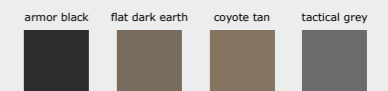

Schusswinkelkompensator  
Angle cosine indicator  
**€ 189,30 | OPTION**

Taktische Blockmontagen  
Tactical blockmounts  
**€ 330,20 | OPTION**

Erdsporn-Mini (Picatinny-Schiene)  
Monopod-Mini (Picatinny-rail)  
**€ 199,90 | OPTION**

VOERE X Zweibein  
VOERE X Bipod  
**€ 320,80 | OPTION**

\* Andere Kaliber, Speziallängen, Drallängen und Beschichtungen sind möglich. / Other calibres, special lengths, twist rates and coatings are possible.  
\*\* Gewichte exkl. VOERE Match Mündungsbremse (ca. 300g) / Weights excl. VOERE Match muzzle brake (ca. 300g)

Art.Nr.: WA2009-00-0006

# VOERE M2 - POLICE EDITION

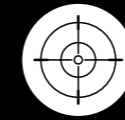

Medium Range  
300 m

Long Range  
1000 m



IT'S MODULAR

## M2 - POLICE EDITION

Schusswinkelkompensator  
Angle Cosine Indicator

€ 189,30 | ca. 50 g



Picatinny-Schiene verstellbar  
Picatinny-rail adjustable

€ 192,50 | ca. 150 g



Stahl Picatinny-Schiene  
Steel Picatinny-rail

€ 106,90 | ca. 180 g



VOERE X-Zweibein  
VOERE X-Bipod  
€ 320,80 | ca. 450 g



Mündungsfeuerdämpfer  
Blast deflector  
€ 120,- | ca. 150 g



Match Mündungsbremse  
Match muzzle Brake  
€ 342,20 | ca. 300 g



End-Barrel Schalldämpfer  
End-Barrel Suppressor  
€ 407,- | ca. 430 g



ab / from  
€ 3.180,10

VOERE M2 - POLICE EDITION in armor black / dark grey mit Zubehör  
VOERE M2 - POLICE EDITION in armor black / dark grey with accessories

Taktische Blockmontage  
Tactical block mount  
€ 330,20 | ca. 260 g

Varmintlauf Stahl / Steel varmint barrel  
€ 919,60 | ca. 1.500 g

Matchlauf Edelstahl geflutet / Stainless steel match barrel fluted  
€ 1.176,30 | ca. 2.400 g | **OPTION**



Picatinny-Schiene (Erdsporn)  
Picatinny-rail (Monopod)

€ 42,80 | ca. 50 g



Erdsporn-Mini  
Monopod-Mini

€ 199,90 | ca. 350 g



Ersatzmagazinhalter  
Spare magazine holder

€ 62,- | ca. 50 g



5-Schuss Magazin  
5-rounds magazine

€ 128,30 | ca. 150 g



10-Schuss Magazin  
10-rounds magazine

€ 320,80 | ca. 600 g

### Mod. M2 - POLICE EDITION

<b>Länge / Length:</b>	ca. 105 cm - 120 cm (abhängig von Kaliber und Schaft) / (depending on calibre and stock)		
<b>Gewicht / Weight:</b>	ca. 4,6 kg - 5,6 kg (Gewehr inkl. Magazin) / (rifle incl. magazine)		
<b>Kaliber / Calibre:*</b>	<b>Drall / Twist:</b>	<b>Lauf / Barrel:**</b>	<b>Magazin / Magazine:</b>
6,5 Creedmoor (Varmint) 308 Win. (Varmint)	1:8" 1:12"	51 cm / 20" / 1,5 kg 51 cm / 20" / 1,5 kg	5-/10-Schuss / 5-/10-rounds 5-/10-Schuss / 5-/10-rounds
6,5 Creedmoor (Match) 308 Win. (Match)	1:8" 1:12"	66 cm / 26" / 2,5 kg 66 cm / 26" / 2,4 kg	5-/10-Schuss / 5-/10-rounds 5-/10-Schuss / 5-/10-rounds
<b>Abzug / Trigger:</b>	Matchdruckpunktabzug (MD) / Two-stage Match trigger		
<b>Sicherung / Safety:</b>	3 Stellungen-Schlagbolzensicherung / 3-position firing pin safety		
<b>Schaft / Stock:</b>	Taktischer Schaft inkl. Klappschaft, integrierter Erdsporn <b>Option:</b> diverse Vorder- und Hinterschäfte Tactical stock incl. folding stock, integrated monopod <b>Option:</b> various front- and rear-stocks		

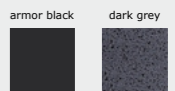

\* Andere Kaliber, Speziallängen, Drallängen und Beschichtungen sind möglich. / Other calibres, special lengths, twist rates and coatings are possible.

\*\* Gewichte exkl. VOERE Match Mündungsbremse (ca. 300g) / Weights excl. VOERE Match muzzle brake (ca. 300g)

Art.Nr.: WA2009-00-0007

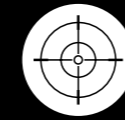

IT'S MODULAR

## THE IDEAL SERVICE WEAPON FOR LONGRANGE APPLICATIONS

6,5x47 Lapua - 408 CT

Längen- und höhenverstellbarer Hinterschaft  
Length- and height adjustable rear stock

ab / from  
€ 6.897,20

115 mm

85 mm

Schaftlängenverstellung  
Lengthwise adjustment

Integrierter Erdsporn  
Integrated monopod

Diverse Abzüge mit Winterabzugsbügel möglich.  
Various triggers with winter trigger possible.

VOERE Taktische Picatinny Blockmontage  
VOERE Tactical Picatinny block mount  
(0/20/35/50 MOA)



Taktischer Tragegriff  
Tactical Carrying Handle  
**OPTION | € 491,90**

Kammergriff Verlängerung  
Bolt handle extension  
**OPTION | € 13,-**

VOERE X3 in flat dark earth mit Zubehör  
VOERE X3 in flat dark earth with accessories

Zweibein-Adapter  
Bipod-Adapter  
**OPTION | € 53,50**

Kaliber- und Laufwechselsystem  
Switch barrel system

UIT-Schiene  
UIT-rail

### Mod. X3

<b>Länge / Length:</b>	ca. 126 cm - 132 cm (abhängig von Kaliber und Schaft) / (depending on calibre and stock)		
<b>Gewicht / Weight:</b>	ca. 7,3 kg - 8,3 kg (Gewehr inkl. Magazin und Mündungsbremse) / (rifle incl. magazine and muzzle brake)		
<b>Kaliber / Calibre:*</b>	<b>Drall / Twist:</b>	<b>Lauf / Barrel:**</b>	<b>Magazin / Magazine:</b>
6,5x47 Lapua	1:8"	66 cm / 26" / 2,2 kg	10-Schuss / 10-rounds (Polymer)
6,5 Creedmoor	1:8"	66 cm / 26" / 2,2 kg	6-Schuss / 6-rounds (Stainless steel)
308 Win.	1:12"	66 cm / 26" / 2,1 kg	10-Schuss / 10-rounds (Polymer)
300 Win. Mag.	1:10"	66 cm / 26" / 2,1 kg	6-Schuss / 6-rounds (Stahl-steel)
300 Norma Mag. (+ € 630,80)	1:15" - 1:9" prog.	72 cm / 28" / 2,3 kg	5-Schuss / 5-rounds (Stahl-steel   Polymer)
338 Lapua Mag. (+ € 630,80)	1:16" - 1:10" prog.	69 cm / 27" / 2,2 kg	5-Schuss / 5-rounds (Stahl-steel   Polymer)
375 SWISS P (+ € 1.101,30)	1:16" - 1:10" prog.	72 cm / 28" / 3,2 kg	5-Schuss / 5-rounds (Stahl-steel   Polymer)
375 CT (+ € 1.101,30)	1:16" - 1:10" prog.	72 cm / 28" / 3,2 kg	5-Schuss / 5-rounds (Stahl-steel)
408 CT (+ € 1.101,30)	1:17" - 1:11" prog.	72 cm / 28" / 3,1 kg	5-Schuss / 5-rounds (Stahl-steel)
<b>Abzug / Trigger:</b>	Matchdruckpunktabzug (MD) / Two-stage Match trigger <b>Option:</b> Direktabzug (MF) / Rückstecher (RST) / Direct trigger, Single-set trigger		
<b>Sicherung / Safety:</b>	3 Stellungs-Schlagbolzensicherung / 3-position firing pin safety		
<b>Schaft / Stock:</b>	Taktischer Schaft inkl. Klappschaft, integrierter Erdsporn <b>Option:</b> diverse Vorder- und Hinterschäfte, Fixschaft Tactical stock incl. folding stock, integrated monopod <b>Option:</b> various front- and rear-stocks, fixed stock		

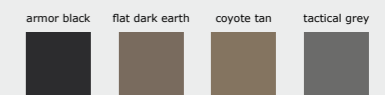

Integrierter Erdsporn  
Integrated monopod



Hinterschaft verstellbar  
Rear stock adjustable



Beidhändiger Magazinhalter  
Ambidextrous magazine release



Hülsenfangsack  
Brass catcher  
**OPTION | € 256,60**

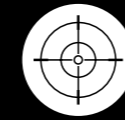

IT'S MODULAR

## THE IDEAL SERVICE WEAPON FOR LONGRANGE APPLICATIONS

6,5x47 Lapua - 408 CT



Snaplocks für Riemenbügel  
Snaplocks for sling swivels

ab / from  
€ 5.892,-

Picatinny Aluminium Handschutz  
Picatinny aluminium hand guard  
**OPTION | € 363,60**

Match Mündungsbremse  
Match muzzle brake



STANDARD

Taktische Mündungsbremse  
Tactical muzzle brake



OPTION

VOERE X3 in tactical grey mit Zubehör  
VOERE X3 in tactical grey with accessories

VOERE Erdsporn-Mini  
VOERE Monopod-Mini  
**OPTION | € 199,90**



Lochschaft  
thumbhole stock

Pistolengriff  
pistol grip



VOERE X3 in armor black mit Lochschaft  
VOERE X3 in armor black with thumbhole stock

### Mod. X3 - POLYMER

<b>Länge / Length:</b>	ca. 128 cm - 134 cm (abhängig von Kaliber und Schaft) / (depending on calibre and stock)		
<b>Gewicht / Weight:</b>	ca. 5,8 kg - 6,8 kg (Gewehr inkl. Magazin und Mündungsbremse) / (rifle incl. magazine and muzzle brake)		
<b>Kaliber / Calibre:*</b>	<b>Drall / Twist:</b>	<b>Lauf / Barrel:**</b>	<b>Magazin / Magazine:</b>
6,5x47 Lapua	1:8"	66 cm / 26" / 2,2 kg	10-Schuss / 10-rounds (Polymer)
6,5 Creedmoor	1:8"	66 cm / 26" / 2,2 kg	6-Schuss / 6-rounds (Stainless steel)
308 Win.	1:12"	66 cm / 26" / 2,1 kg	10-Schuss / 10-rounds (Polymer)
300 Win. Mag.	1:10"	66 cm / 26" / 2,1 kg	6-Schuss / 6-rounds (Stahl-steel)
300 Norma Mag. (+ € 630,80)	1:15" - 1:9" prog.	72 cm / 28" / 2,3 kg	5-Schuss / 5-rounds (Stahl-steel   Polymer)
338 Lapua Mag. (+ € 630,80)	1:16" - 1:10" prog.	69 cm / 27" / 2,2 kg	5-Schuss / 5-rounds (Stahl-steel   Polymer)
375 SWISS P (+ € 1.101,30)	1:16" - 1:10" prog.	72 cm / 28" / 3,2 kg	5-Schuss / 5-rounds (Stahl-steel   Polymer)
375 CT (+ € 1.101,30)	1:16" - 1:10" prog.	72 cm / 28" / 3,2 kg	5-Schuss / 5-rounds (Stahl-steel)
408 CT (+ € 1.101,30)	1:17" - 1:11" prog.	72 cm / 28" / 3,1 kg	5-Schuss / 5-rounds (Stahl-steel)
<b>Abzug / Trigger:</b>	Matchdruckpunktanzug (MD) / Two-stage Match trigger <b>Option:</b> Direktanzug (MF), Rückstecher (RST) / Direct trigger, Single-set trigger		
<b>Sicherung / Safety:</b>	3 Stellungen-Schlagbolzensicherung / 3-position firing pin safety		
<b>Schaft / Stock:</b>	Taktischer Schaft inkl. Klappschaft, integrierter Erdsporn <b>Option:</b> diverse Vorder- und Hinterschäfte Tactical stock incl. folding stock, integrated monopod <b>Option:</b> various front- and rear-stocks		

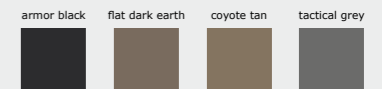

\* Andere Kaliber, Speziallängen, Drallängen und Beschichtungen sind möglich. / Other calibres, special lengths, twist rates and coatings are possible.  
\*\* Gewichte exkl. VOERE Match Mündungsbremse (ca. 300g) / Weights excl. VOERE Match muzzle brake (ca. 300g)

Art.Nr.: WA2012-00-0004

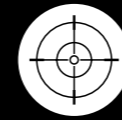

IT'S MODULAR

## THE HIGH-TECH RIFLE FOR LONGRANGE APPLICATIONS

300 Norma Mag. - 408 CT

Picatinny-Schiene MIL-STD 1913 (20 MOA)  
Picatinny-rail MILD-STD 1913 (20 MOA)

Beidseitiger Klappschaft rechts / links  
Ambidextrous folding stock right / left

ab / from  
€ 8.597,30



Beidseitiges Auswurffenster  
Ambidextrous ejection port

Integrierter Erdsporn  
Integrated monopod



Beidseitiger Magazinhalter  
Ambidextrous magazine release



Diverse Vorderschäfte  
Various fore-ends  
**OPTION**



2 Stellung-Schlagbolzensicherung  
2-position firing pin safety



Klappschaft rechts / links  
Folding stock right / left



VOERE X4 in armor black



ab / from  
€ 1.604,-

Lauflänge / Barrel length: 69 cm / 72 cm

Weaver-Schienen  
Weaver-rails

Zweibein-Adapter  
Bipod-adapter

VOERE X4 in flat dark earth mit Zubehör  
VOERE X4 in flat dark earth with accessories

VOERE X Zweibein mit Universalaufnahme  
VOERE X bipod with universal device  
**OPTION | € 320,80**

Anbindung für Schalldämpfer  
Connection for suppressors  
(M18x1 left)

### Mod. X4

<b>Länge / Length:</b>	ca. 138 cm - 141 cm (abhängig von Kaliber und Schaft) / (depending on calibre and stock)		
<b>Gewicht / Weight:</b>	ca. 8,7 kg - 9,7 kg (Gewehr inkl. Magazin und Mündungsbremse) / (rifle incl. magazine and muzzle brake)		
<b>Kaliber / Calibre:*</b>	<b>Drall / Twist:</b>	<b>Lauf / Barrel: **</b>	<b>Magazin / Magazine:</b>
300 Norma Mag.	1:15" - 1:9" prog.	72 cm / 28" / 2,6 kg	5-Schuss / 5-rounds (Stahl-steel   Polymer)
338 Lapua Mag.	1:16" - 1:10" prog.	69 cm / 27" / 2,5 kg	5-Schuss / 5-rounds (Stahl-steel   Polymer)
375 SWISS P (+ € 470,50)	1:16" - 1:10" prog.	72 cm / 28" / 3,5 kg	5-Schuss / 5-rounds (Stahl-steel   Polymer)
375 CT (+ € 470,50)	1:16" - 1:10" prog.	72 cm / 28" / 3,5 kg	5-Schuss / 5-rounds (Stahl-steel)
408 CT (+ € 470,50)	1:17" - 1:11" prog.	72 cm / 28" / 3,4 kg	5-Schuss / 5-rounds (Stahl-steel)
<b>Abzug / Trigger:</b>	Matchdruckpunkt-Abzug (MD) / Two-stage Match trigger <b>Option:</b> Direktabzug (MF) / Rückstecher (RST) / Direct trigger / Single-set trigger		
<b>Sicherung / Safety:</b>	2-Stellungssicherung inkl. automatischer Schlagbolzensicherung 2-position safety incl. automatic firing pin safety		
<b>Schaft / Stock:</b>	Taktischer Schaft inkl. Klappschaft, integrierter Erdsporn <b>Option:</b> diverse Vorder- und Hinterschäfte, Fixschaft Tactical stock incl. folding stock, integrated monopod <b>Option:</b> various front- and rear-stocks, fixed stock		

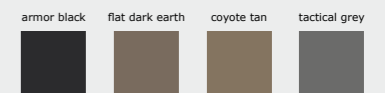

\* Andere Kaliber, Speziallängen, Drallängen und Beschichtungen sind möglich. / Other calibres, special lengths, twist rates and coatings are possible.

\*\* Gewichte exkl. VOERE Match Mündungsbremse (ca. 300g) / Weights excl. VOERE Match muzzle brake (ca. 300g)

Art.Nr.: WA2013-00-0001

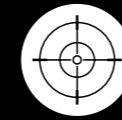

IT'S MODULAR

## THE AUSTRIAN HIGH-TECH BIG FIFTY

416 Barrett - 50 Browning

Picatinny-Schiene MIL-STD 1913 (20 MOA)  
Picatinny-rail MILD-STD 1913 (20 MOA)

Innovative Längenverstellung  
Innovative lengthwise adjustment

ab / from  
€ 9.538,30

Handauflage  
Hand rest

4-Schuss Magazin  
4-rounds magazine

Zweibein-Adapter  
Bipod-adapter

VOERE X5 in armor black mit Vorderschaft lang und VOERE SPORT End-Barrel Schalldämpfer X5  
VOERE X5 in armor black with fore-end long and VOERE TARGET End-Barrel Suppressor X5

VOERE X5 in camouflage (Einzellader)  
VOERE X5 in camouflage (single-shot bolt action rifle)



Diverse Vorderschäfte  
Various fore-ends  
**OPTION**



Beidhändiger Magazinhalter  
Ambidextrous magazine release



Winterabzugsbügel  
Winter trigger guard



Taktische Mündungsbremse  
Tactical Muzzle Brake  
**STANDARD**

Kaliber- und Laufwechsel  
Barrel and calibre changeable

Adapter für Schalldämpfer (M28x1,5 links)  
Adapter for suppressors (M28x1,5 left)

Edelstahl Matchlauf, Ø 32 mm  
Stainless steel Match barrel, Ø 32 mm

VOERE X5 in flat dark earth mit Zubehör  
VOERE X5 in flat dark earth with accessories

### Mod. X5

<b>Länge / Length:</b>	ca. 150 cm - 160 cm (abhängig von Kaliber und Schaft) / (depending on calibre and stock)		
<b>Gewicht / Weight:</b>	ca. 12,5 kg - 13,1 kg (Gewehr inkl. Magazin und Mündungsbremse) / (rifle incl. magazine and muzzle brake)		
<b>Kaliber / Calibre:*</b>	<b>Drall / Twist:</b>	<b>Lauf / Barrel:**</b>	<b>Magazin / Magazine:</b>
416 TYR	1:13"	91 cm / 36" / 6,4 kg	4-Schuss / 4-rounds (Stahl-steel)
416 Barrett	1:12"	81 cm / 32" / 5,8 kg	4-Schuss / 4-rounds (Stahl-steel)
460 Steyr	1:14"	86 cm / 34" / 6,1 kg	4-Schuss / 4-rounds (Stahl-steel)
50 Browning	1:15"	81 cm / 32" / 6 kg	4-Schuss / 4-rounds (Stahl-steel)
12,7 x 108	1:15"	81 cm / 32" / 6 kg	4-Schuss / 4-rounds (Stahl-steel)
<b>Abzug / Trigger:</b>	Matchdruckpunkt-Abzug (MD) / Two-stage Match trigger <b>Option:</b> Direktabzug (MF), Rückstecher (RST) / Direct trigger, Single-set trigger		
<b>Sicherung / Safety:</b>	2-Stellungssicherung inkl. automatischer Schlagbolzensicherung 2-position safety incl. automatic firing pin safety		
<b>Schaft / Stock:</b>	Taktischer Schaft inkl. Klappschaft, integrierter Erdsporn <b>Option:</b> diverse Vorder- und Hinterschäfte, Fixschaft Tactical stock incl. folding stock, integrated monopod <b>Option:</b> various front- and rear-stocks, fixed stock		

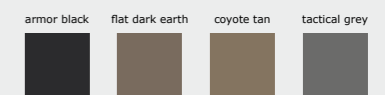

\* Andere Kaliber, Speziallängen, Drallängen und Beschichtungen sind möglich. / Other calibres, special lengths, twist rates and coatings are possible.

\*\* Gewichte exkl. VOERE Match Mündungsbremse (ca. 300g) / Weights excl. VOERE Match muzzle brake (approx. 300g)

Art.Nr.: WA2013-00-0002

## KALIBERPALETTE | CALIBRE RANGE

KALIBERPALETTE   CALIBRE RANGE						
	Kalibergruppe	Dralllängen	Mod. M2	Mod. X3	Mod. X4	Mod. X5
223 Rem.	MI	1:9"	1			
6,5x47 Lapua	ST	1:8"	15	31		
6,5 Creedmoor	ST	1:8"	15	31		
6,5x55 SE	ST	1:8,5"	5			
308 Win.	ST	1:12"	5	31		
300 Win. Mag.	MG	1:10"	9	32		
300 Norma Mag.	UM	1:15"-1:9" progr.		33	33	40
338 Lapua Mag.	UM	1:16"-1:10" progr.		33	33	40
375 SWISS P	UM	1:16"-1:10" progr.		33	33	40
375 CT	XM	1:16"-1:10" progr.		34	34	41
408 CT	XM	1:17"-1:11" progr.		34	34	41
416 TYR	TYR	1:13"				38
416 Barrett	BMG	1:12"				38
460 Steyr	BMG	1:14"				37
50 Browning	BMG	1:15"				39
12,7 x 108	RUS	1:15"				37

Magazinnummern / magazine numbers

Andere Kaliber, Speziallängen und Dralllängen möglich. / Other calibres, special lengths and twist rates are possible.

**Bitte beachten Sie, dass die Kaliberauswahl ständigen Änderungen und Erweiterungen unterliegt!**

**Please note, that the calibre list is subject to constant changes and extensions!**

## MODULARITÄT IN IHRER PERFEKTION MODULARITY IN ITS PERFECTION

Unsere Präzisionsrepetierer verfügen über ein modulares System. Einzelne Baugruppen können ausgetauscht werden und sind mit einem Schaft-, Kaliber- und Laufwechsel ausgestattet.

All our precision rifles are equipped with a switch barrel system. Individual assemblies can be replaced. Barrels, calibres and stocks can be interchanged in different models.



**Mod. M2**

VOERE M2 in armor black mit X4/X5 Hinterschaft und Vorderschaft lang mit Handschutz  
VOERE M2 in armor black with X4/X5 rear-stock and front-stock long with handguard



**Mod. X3**

VOERE X3 in camouflage mit Mündungsfeuerdämpfer  
VOERE X3 in camouflage with blast deflector

camouflage

Aufpreis / Surcharge: € 385,-



**Mod. X4**

VOERE X4 in armor black mit Vorderschaft lang mit Aluminium-Handschutz M-LOK  
VOERE X4 in armor black with fore-end long and aluminium handguard M-LOK



**Mod. X5**

VOERE X5 in olive (Einzellader)  
VOERE X5 in olive (single-shot bolt action rifle)

# DYNAMISCHES SCHIESSEN

## DYNAMIC SHOOTING

### VOERE DYNAMISCHES SCHIESSEN

Leichte und dynamische Sportbüchsen für das bewegte Schießen in unterschiedlichen Schießpositionen  
(stehend, laufend, sitzend, liegend)

### VOERE DYNAMIC SHOOTING

Light weight and dynamic rifles for moving shooting in different shooting positions  
(standing, running, sitting, prone shooting)

## MODELLÜBERSICHT | MODEL OVERVIEW



**Mod. VICTOR 3 - JAGD | HUNTING**

243 Win. / 308 Win.

ab / from **€ 2.721,40** | Art.Nr.: WA2021-00-(0001/0006/0010)



**Mod. VICTOR 3 - SPORT**

6,5 Creedmoor / 308 Win.

ab / from **€ 2.721,40** | Art.Nr.: WA2021-00-(0002/0007/0011)



**Mod. VICTOR 3 - INTEGRAL**

Jagdlauf inkl. Integral Over-Barrel Schalldämpfer | 308 Win.  
Hunting barrel incl. Integral Over-Barrel Suppressor | 308 Win.

ab / from **€ 2.998,80** | Art.Nr.: WA2021-00-(0004/0008/0012)



**Mod. ALPHA 3**

223 Rem. / 308 Win.

ab / from **€ 2.998,80** | Art.Nr.: WA2022-00-0001

## Mod. VICTOR 3 - STANDARD SPORTBÜCHSE Mod. VICTOR 3 - STANDARD SPORT BOLT ACTION RIFLE

Einteilige Aluminium Picatinny-Basis im System integriert (20 MOA)  
One-part Aluminium Picatinny-base integrated in the action (20 MOA)

ab / from  
€ 2.721,40



Varmint Stahl-Karbonlauf (Ø 23 mm) - Karbon Oberfläche  
Varmint Steel-Carbon-barrel (Ø 23 mm) - carbon surface

Mündungsgewinde: M14x1  
Muzzle thread: M14x1

**VOERE VICTOR 3 - JAGD**  
Varmint Stahl-Karbonlauf (Ø 23 mm)  
Varmint Steel-Carbon barrel (Ø 23 mm)  
(HERA-ARMS EDITION)

Matchdruckpunktabzug inkl. Finger-Stop  
Two-stage Match trigger incl. Finger-Stop  
**STANDARD**

HERA H7 Magazin (5-Schuss) AICS Standard  
HERA H7 Magazine (5-rounds) AICS Standard  
**STANDARD**

ab / from  
€ 2.721,40



### VOERE VICTOR 3 - SPORT

Stahl Matchlauf, gehämmert (Ø 29 mm)  
Steel Match-barrel, hammer forged (Ø 29 mm)

(MAGPUL® EDITION)

ab / from  
€ 2.998,80



### VOERE VICTOR 3 - INTEGRAL

Stahl Jagdlauf (Ø 16 mm) inkl. Integral Over-Barrel Schalldämpfer  
Steel Hunting-barrel (Ø 16 mm) incl. Integral Over-Barrel Suppressor

(GRS Berserk EDITION)

**VOERE System kompatibel mit Remington 700® Short Action und AICS Magazinen**  
**VOERE Action compatible with Remington 700® Short Action and AICS magazines**

## Mod. VICTOR 3

**NEW**

<b>Länge / Length:</b>	ca. 105 cm (Jagd) <sup>1</sup>   ca. 110 cm (Sport) <sup>2</sup>   ca. 108 cm (Integral) <sup>3</sup>					
<b>Gewicht / Weight:</b>	ca. 3,3 kg (Jagd) <sup>1</sup>   ca. 4,7 kg (Sport) <sup>2</sup>   ca. 3,7 kg (Integral) <sup>3</sup>					
<b>Kaliber / Calibre:*</b>	<b>Drill / Twist:</b>			<b>Laufänge / Barrel length:</b>		
	<b>Jagd<sup>1</sup></b>	<b>Sport<sup>2</sup></b>	<b>Integral<sup>3</sup></b>	<b>Jagd<sup>1</sup></b>	<b>Sport<sup>2</sup></b>	<b>Integral<sup>3</sup></b>
6,5 Creedmoor	-	1:8"	-	-	60 cm	42 cm
243 Win.	1:10"	-	-	55 cm	-	-
308 Win.	1:12"	1:12"	1:12"	55 cm	60 cm	42 cm
<b>Magazin / Magazine:</b>	5-Schuss Polymermagazin (AICS Standard) 5-rounds polymer magazine (AICS Standard)					
<b>Abzug / Trigger:</b>	Matchdruckpunktabzug (MD) inkl. Finger-Stop Two-stage Match trigger (MD) incl. Finger-Stop					
<b>Schaft / Stock:**</b>	HERA H7 Schaft / Magpul® Hunter Schaft / GRS Berserk Synthetikschaft HERA H7 Chassis / Magpul® Hunter stock / GRS Berserk synthetic stock					

\* Andere Kaliber auf Anfrage / Other calibres on request

\*\* VOERE System passend für alle Remington 700® Short Action Schäfte. / VOERE action suitable for all Remington 700® Short Action stocks.

Art.Nr.: WA2021-00-(0001-0012)

## Mod. ALPHA 3 - UNIVERSELLE SPORTBÜCHSE Mod. ALPHA 3 - UNIVERSAL SPORT BOLT ACTION RIFLE

VOERE System kompatibel mit AICS | Passend für HERA-ARMS Vorderschäfte und AR15 Hinterschäfte.  
VOERE Action compatible with AICS | Suitable for HERA-ARMS front-stocks and AR15 rear-stocks.

Einteilige Aluminium Picatinny-Basis im System integriert (0 MOA)  
One-part Aluminium Picatinny-base integrated in the action (0 MOA)



### PRODUKTDETAILS | PRODUCT DETAILS

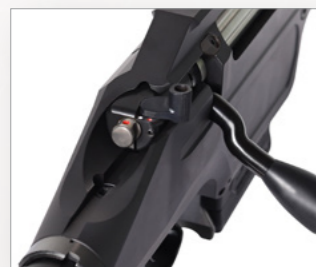

3-Stellungs Schlagbolzensicherung  
3-position firing pin safety



Winterabzugsbügel  
Winter trigger guard  
**STANDARD**



Robuste 3-Warzen Verriegelung  
Robust 3-lug bolt



Edelstahl Match Mündungsbremse  
Stainless steel Match muzzle brake  
**OPTION | € 342,20**

### Mod. ALPHA 3

NEW

<b>Länge / Length:</b>	ca. 98 cm - 106 cm
<b>Gewicht / Weight:</b>	ca. 4,6 kg
<b>Lauf / Barrel:</b>	Stahl Matchlauf, gehämmert (Ø 29 mm) / Steel Match-barrel, hammer forged (Ø 29 mm) Lauflänge / Barrel length: 52 cm
<b>Kaliber / Calibre:*</b>	223 Rem., 308 Win.
<b>Magazin / Magazine:</b>	5-Schuss Polymermagazin (AICS Standard) 5-rounds polymer magazine (AICS Standard)
<b>Abzug / Trigger:</b>	Matchdruckpunktanzug (MD) / Two-stage Match trigger <b>Option:</b> Direktabzug (MF), Rückstecher (RST) / Direct trigger, Single-set trigger
<b>Schaft / Stock:</b>	Taktischer Schaft AR15-Standard / Tactical stock AR15-Standard

\* Andere Kaliber auf Anfrage / Other calibres on request

Art.Nr.: WA2022-00-0001

# SPORT SCHIESSEN SPORT SHOOTING

## VOERE SPORT SCHIESSEN

Universelle Sportgewehre zum Schießen auf dem Schießplatz, zum Üben und Jagdmatch Schießen

## VOERE SPORT SHOOTING

Universal rifles for shooting on the range, for practice and Hunting Match shooting

## MODELLÜBERSICHT | MODEL OVERVIEW



**Mod. LBW Light-Varmint**

Sport Repetierbüchse / Sport Bolt Action Rifle

ab / from € 2.598,50 | Art.Nr.: WA2003-00-007



**Mod. LBW - Barreled Action**

Jagd-, Varmint- und Matchläufe / Hunting-, Varmint- and Match-barrels

ab / from € 1.993,20 | Art.Nr.: WA2003-00-00..



**Mod. LBW Heavy-Varmint**

Varmint Repetierbüchse / Varmint Bolt Action Rifle

ab / from € 3.180,10 | Art.Nr.: WA2003-00-0008



**Mod. LBW Match-Varmint**

Match Repetierbüchse / Match Bolt Action Rifle

ab / from € 3.693,40 | Art.Nr.: WA2003-00-0008

# VOERE LBW Light-Varmint



Medium Range  
300 m



**VOERE**  
SPORT SHOOTING

IT'S MODULAR

## Mod. LBW LIGHT-VARMINT - SPORT REPETIERBÜCHSE

Mod. LBW LIGHT-VARMINT - SPORT BOLT ACTION RIFLE

ab / from  
**€ 2.598,40**



Jagd Stahl-Karbonlauf / Hunting steel-carbon barrel  
**OPTION** | (Kaliber auf Anfrage / Calibre on request)

**VOERE LBW Light-Varmint mit GGS-Schaft und Zubehör**  
**VOERE LBW Light-Varmint with GGS-stock and accessory**

ab / from **€ 2.996,10**

Handspannung oder 3-Stellungssicherung  
Manual cocking safety or 3-position safety



**VOERE LBW Light-Varmint mit GRS-Schaft inkl. Zubehör**  
**VOERE LBW Heavy-Varmint with GRS-stock incl. accessory**

ab / from **€ 2.598,50**



**VOERE LBW Light-Varmint mit VOERE Polymerschaft inkl. Zubehör**  
**VOERE LBW Light-Varmint with VOERE Polymerstock incl. accessory**

ab / from **€ 2.598,50**



Ersatzmagazinhalter  
Spare magazine holder

**OPTION | € 62,-**



Picatinny-Schiene  
Picatinny-rail

**OPTION | € 42,80**

### Mod. LBW Light-Varmint

<b>Länge / Length:</b>	ca. 113 cm ( <b>MI / ST</b> ) - 118 cm ( <b>ME / MG / UM</b> )
<b>Gewicht / Weight:</b>	ca. 3,5 kg - 3,9 kg
<b>Lauf / Barrel:</b>	Jagd Stahllauf ohne Visierung / Hunting steel-barrel without sight Lauf­länge / Barrel length: 60 cm / 24" ( <b>MI / ST</b> )   65 cm / 26" ( <b>ME / MG / UM</b> ) <b>Option:</b> Jagd Stahl-Karbonlauf / Hunting steel-carbon barrel (Kaliber auf Anfrage / Calibre on request)
<b>Kaliber / Calibre:**</b>	<b>Mini (MI):</b> 222 Rem.* / 223 Rem.* <b>Standard (ST):</b> 6,5x47 Lapua   6,5x55 SE   6,5x57   7,5x55 Suisse   7x57   7x64*   8x57 IS   9,3x62* 22-250 Rem.   243 Win.   25-06 Rem.   270 Win.*   7mm-08 Rem.   308 Win.*   30-06* <b>Medium (ME):</b> 6,5x68   8x68 S <b>Magnum (MG):</b> 270 WSM*   7mm WSM.   7mm Rem. Mag.   300 WSM   300 Win. Mag.* 300 Wby. Mag.   338 Win. Mag.   375 H&H Mag.* <b>Ultramagnum (UM):</b> 338 Lapua Mag. (+ € 427,70) (Kein Kaliberwechsel möglich! / No calibre change possible!)
<b>Magazin / Magazine:</b>	Stahlmagazin 2/3-Schuss / Steel magazine 2/3-rounds <b>Option:</b> Stahlmagazin 4/5-Schuss / Steel magazine 4/5-rounds
<b>Abzug / Trigger:</b>	Direktabzug (MF) / Direct trigger <b>Option:</b> Matchdruckpunkt­abzug (MD), Rückstecher (RST) / Two-stage Match trigger, Single-set trigger
<b>Sicherung / Safety:</b>	Handspanner mit Kam­mersperre / Manual cocking safety with bolt lock <b>Option:</b> 3 Stellungen-Schlagbolzensicherung / 3-position firing pin safety
<b>Schaft / Stock:</b>	GRS-Schichtholz­schaft "SPORTER" / GRS-laminated wood stock "SPORTER" VOERE Polymers­chäfte (2 Varianten) / VOERE polymer stocks (2 versions) GGs "REX" laminiertes Epoxidharz­schaft / GGS "REX" laminated epoxy resin stock

\* Läufe besitzen bereits ein Gewinde am Lauf (M14x1 / Länge: 15 mm) / Barrels already have a thread on the barrel (M14x1 / length: 15 mm)

\*\* Andere Kaliber, Speziallängen und Drallängen möglich. / Other calibres, special lengths and twist rates are possible.

Art.Nr.: WA2003-00-0007

# VOERE LBW Heavy-Varmint



Medium Range  
300 m



**VOERE**  
SPORT SHOOTING

IT'S MODULAR

## Mod. LBW HEAVY-VARMINT - VARMINT REPETIERBÜCHSE

Mod. LBW HEAVY-VARMINT - VARMINT BOLT ACTION RIFLE



Karbonfaserverstärkter Polymerschaft  
Carbon fibre reinforced polymerstock

ab / from  
€ 3.180,10

Jagdlicher Kammergriff  
Hunting bolt handle

Ersatzmagazinhalter und Picatinny-Schiene für Erdsporn  
Spare magazine holder and Picatinny-rail for monopod  
**OPTION | € 104,80**



Mündungsbremsen mit Gewinde für Schalldämpfer (M18x1)  
Muzzle brakes with thread for suppressors (M18x1)

**OPTION | € 139,10**

VOERE LBW Heavy-Varmint mit VOERE Polymerschaft und Mündungsbremse  
VOERE LBW Heavy-Varmint with VOERE Polymerstock and muzzle brake

ab / from **€ 3.180,10**

Picatinny-Schiene für Zweibein  
Picatinny-rail for bipod

**STANDARD**



VOERE LBW Heavy-Varmint mit GRS Hunter-Light Schaft (Lauflänge: 51 cm)  
VOERE LBW Heavy-Varmint with GRS Hunter-Light stock (Barrel length: 51 cm)

ab / from **€ 3.180,10**



VOERE LBW Heavy-Varmint mit GGS-Schaft und VOERE End-Barrel Schalldämpfer  
VOERE LBW Heavy-Varmint with GGS and VOERE End-Barrel Suppressor

ab / from **€ 3.583,50**

## Mod. LBW Heavy-Varmint

<b>Länge / Length:</b>	ca. 104 cm - 119 cm
<b>Gewicht / Weight:</b>	ca. 3,9 kg - 4,3 kg
<b>Lauf / Barrel:</b>	Varmint Stahl Lauf ohne Visierung / Varmint steel barrel without sight Lauflänge / Barrel length: 51 cm / 66 cm (kaliberabhängig / depending on calibre) <b>Option:</b> Varmint Stahl-Karbonlauf / Varmint steel-carbon barrel (Kaliber auf Anfrage / Calibre on request)
<b>Kaliber / Calibre:</b> *	6,5 Creedmoor*   6,5x47 Lapua   6,5x55 SE   7mm-08 Rem.   22-250 Rem.   25-06 Rem.   243 Win.   308 Win.*
<b>Magazin / Magazine:</b>	Stahlmagazin 4/5-Schuss / Steel magazine 4/5-rounds <b>Option:</b> Stahlmagazin 2/3-Schuss / Steel magazine 2/3-rounds
<b>Abzug / Trigger:</b>	Direktabzug (MF) / Direct trigger <b>Option:</b> Matchdruckpunkt abzug (MD), Rückstecher (RST) / Two-stage Match trigger, Single-set trigger
<b>Sicherung / Safety:</b>	Handspanner mit Kammer Sperre / Manual cocking safety with bolt lock <b>Option:</b> 3 Stellungen-Schlagbolzensicherung / 3-position firing pin safety
<b>Schaft / Stock:</b>	GRS-Schichtholzschäft "SPORTER" / GRS-laminated wood stock "SPORTER" VOERE Polymerschäfte (2 Varianten) / VOERE polymer stocks (2 versions) GGs "REX" laminiertes Epoxidharzschäft / GGS "REX" laminated epoxy resin stock

\* Läufe mit Länge: 51 cm und Gewinde am Lauf (M18x1 / Länge: 20 mm) / Barrels with length: 51 cm and thread on the barrel (M18x1 / length: 20 mm)

Art.Nr.: WA2003-00-0008

\*\* Andere Kaliber, Speziallängen und Drallängen möglich. / Other calibres, special lengths and twist rates are possible.



Medium Range  
300 m

Long Range  
1000 m

IT'S MODULAR

## Mod. LBW MATCH-VARMINT - MATCH REPETIERBÜCHSE

Mod. LBW MATCH-VARMINT - MATCH BOLT ACTION RIFLE

Hervorragende Präzision - unter 0,5 MOA / Outstanding accuracy - 0.5 MOA or better



Taktischer Kammergriff  
Tactical bolt handle

ab / from  
€ 3.693,40

Cerakote Beschichtung für Lauf  
Cerakote coating for barrel  
**OPTION | € 192,50**

Match Mündungsbremse mit 3 Kammern  
Match muzzle brake with 3 chambers  
**OPTION | € 342,20**

VOERE Match-Varmint mit GRS-Schichtholzschäft "SPORTER"  
VOERE Match-Varmint with GRS laminated wood stock "SPORTER"  
ab / from **€ 3.693,40**

VOERE X Zweibein mit Universalaufnahme  
VOERE X bipod with universal device  
**OPTION | € 320,80**

Picatinny-Schiene (0-40 MOA)  
Picatinny-rail (0-40 MOA)



VOERE Match-Varmint mit GRS-Schichtholzschäft "SPORTER" blau  
VOERE Match-Varmint with GRS-laminated stock "SPORTER" blue  
ab / from **€ 3.693,40**



VOERE Match-Varmint mit GGS-Schäft und Match Mündungsbremse  
VOERE Match-Varmint with GGS-stock and Match muzzle brake  
ab / from **€ 3.977,90**

### Mod. LBW Match-Varmint

<b>Länge / Length:</b>	ca. 103 cm - 121 cm (abhängig von Kaliber und Schäft) / (depending on calibre and stock)		
<b>Gewicht / Weight:</b>	ca. 4,5 kg - 5,2 kg (Schäft, System, Verschluss, Magazin, Lauf) / (stock, action, bolt, magazine, barrel)		
<b>Kaliber / Calibre:*</b>	<b>Drall / Twist:</b>	<b>Lauf / Barrel:**</b>	<b>Magazin / Magazine:</b>
223 Rem.	1:9"	51 cm / 20" / 2,1 kg	5-Schuss / 5-rounds
6,5x47 Lapua	1:8"	66 cm / 26" / 2,5 kg	5-Schuss / 5-rounds
6,5 Creedmoor	1:8"	66 cm / 26" / 2,5 kg	5-/10-Schuss / 5-/10-rounds (Stahl-steel)
6,5x55 SE	1:8,5"	66 cm / 26" / 2,5 kg	5-/10-Schuss / 5-/10-rounds (Stahl-steel)
308 Win.	1:12"	66 cm / 26" / 2,4 kg	5-/10-Schuss / 5-/10-rounds (Stahl-steel)
300 Win. Mag.	1:10"	66 cm / 26" / 2,4 kg	4-Schuss / 4-rounds
300 Norma Mag. (+ € 427,70)	1:15"-1:9" prog.	69 cm / 27" / 2,6 kg	4-Schuss / 4-rounds
338 Lapua Mag. (+ € 427,70)	1:16" - 1:10" prog.	69 cm / 27" / 2,5 kg	4-Schuss / 4-rounds
<b>Abzug / Trigger:</b>	Direktabzug (MF) / Direct trigger <b>Option:</b> Matchdruckpunktabzug (MD), Rückstecher (RST) / Two-stage Match trigger, Single-set trigger		
<b>Sicherung / Safety:</b>	Handspanner mit Kammer Sperre / Manual cocking safety with bolt lock <b>Option:</b> 3 Stellungs-Schlagbolzensicherung / 3-position firing pin safety		
<b>Schäft / Stock:</b>	GRS-Schichtholzschäft "SPORTER" / GRS-laminated wood stock "SPORTER" VOERE Polymerschäfte (2 Varianten) / VOERE polymer stocks (2 versions) GGS "REX" laminiertes Expoxidharzschäft / GGS "REX" laminated epoxy resin stock		

\* Andere Kaliber, Speziallängen, Drallängen und Beschichtungen sind möglich. / Other calibres, special lengths, twist rates and coatings are possible.

\*\* Gewichte exkl. VOERE Match Mündungsbremse (ca. 300g) / Weights excl. VOERE Match muzzle brake (ca. 300g)

Art.Nr.: WA2003-00-0009

# KLEINKALIBER SCHIESSEN

## RIMFIRE SHOOTING

### VOERE KLEINKALIBER SCHIESSEN

Unsere Kleinkaliber Repetierbüchsen begeistern schon seit mehr als 40 Jahren unsere Kunden. Auf diesen Entwicklungen aufbauend entwickelten wir unser Modell K15A, wodurch wir diese Tradition fortführen.

Durch unsere innovativen Wechselsysteme für unsere Modelle VICTOR 3 und Tirolerin sind Kaliber von .22 bis .308 in einem System / Gewehr möglich.

### VOERE RIMFIRE SHOOTING

*Our Rimfire Bolt Action Rifles impress our customers for more than 40 years. Building on these developments, we created our Model K15A, continuing this tradition.*

*Through our new innovative interchangeable actions for our Models VICTOR 3 and Tirolerin calibres .22 - .308 are possible in one action.*

### MODELLÜBERSICHT | MODEL OVERVIEW



**Mod. K15A Standard**  
Kleinkaliber Repetierbüchse / *Rimfire Bolt Action Rifle*  
ab / from € 599,- | (Art.Nr.: WA2015-00-0002)



**Mod. K15A Integral**  
Kleinkaliber Repetierbüchse mit Integral Schalldämpfer  
*Rimfire Bolt Action Rifle with Integral Suppressor*  
ab / from € 844,90 | (Art.Nr.: WA2015-00-0003)



**Mod. K15A Longrange**  
Kleinkaliber Longrange Repetierbüchse designed for NRL 22® (Special)  
*Longrange Rimfire Bolt Action Rifle designed for NRL 22® (Special)*  
ab / from € 999,- | (Art.Nr.: WA2015-00-0005)



**Mod. Tirolerin - KK / Randfeuer**  
**Mod. Tirolerin - Rimfire**  
Kleinkaliber Wechsellaufsystem | *Rimfire Interchangeable Barrel Actions*  
ab / from € 2.664,50 | (Art.Nr.: WA2006-00-0003)



**Mod. VICTOR 3 - KK / Randfeuer / Longrange**  
**Mod. Tirolerin - Rimfire / Longrange**  
Kleinkaliber Longrange Repetierbüchse | *Longrange Rimfire Bolt Action Rifle*  
ab / from € 1.349,90 | (Art.Nr.: WA2021-00-0005)



## Mod. K15A - KLEINKALIBER REPETIERBÜCHSE

### Mod. K15A - BOLT ACTION RIMFIRE RIFLE



Diverse Weaver-Schienen / Various Weaver-rails

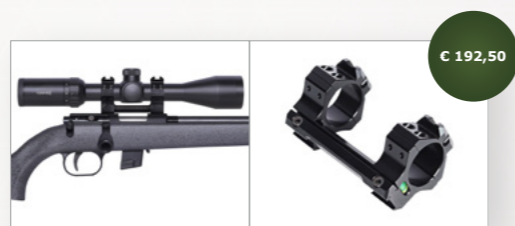

Taktische Blockmontage (Ø 25,4 mm / 30 mm)  
Tactical Block mount (Ø 25.4 mm / 30 mm)



Schlagbolzensicherung  
Firing pin safety



Öffnungsspanner Verschluss  
Cock-on-open bolt



**End-Barrel Schalldämpfer JAGD**  
für Klein- und Schonzeitkaliber  
**End-Barrel Suppressor HUNTING**  
for Rimfire and closed season calibres

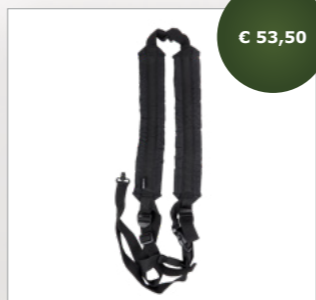

Biathlonriemen inkl. Snaplocks  
Biathlon sling incl. Snaplocks



Mod. K15A			
<b>Länge / Length:</b>	ca. 94 cm (Standard / Longrange) <sup>1,3</sup>   ca. 90 cm (Integral) <sup>2</sup>		
<b>Gewicht / Weight:</b>	ca. 1,4 kg (Standard) <sup>1</sup>   ca. 1,6 kg (Integral) <sup>2</sup>   ca. 2,8 kg (Longrange) <sup>3</sup>		
<b>Kaliber / Calibre:*</b>	<b>Drall / Twist:</b>	<b>Lauf / Barrel:</b>	<b>Magazin / Magazine:</b>
.22 lr.	1:16"	48 cm (Standard / Longrange) <sup>1,3</sup> / 24 cm (Integral) <sup>2</sup>	5-Schuss / 5-rounds
<b>Abzug / Trigger:</b>	Druckpunktanzug / Two-stage trigger <b>Optional:</b> Matchdruckpunktanzug (MD) mit / ohne Finger-Stop Two-stage Match trigger with / without Finger-Stop		
<b>Sicherung / Safety:</b>	Schlagbolzensicherung / Firing pin safety		
<b>Schaft / Stock:</b>	<b>Beschichtung / Coating: dark grey**</b> Höhen- und längenverstellbarer karbonfaserverstärkter Polymerschäft mit Sandoberfläche Height and length adjustable polymerstock with sand surface		

\* Andere Kaliber auf Anfrage / Other calibres on request  
\*\* Andere Beschichtungen auf Anfrage / Other coatings on request



## Mod. TIROLERIN - RANDFEUER Mod. TIROLERIN - RIMFIRE

Kombiabzug (Rückstecher / Direktabzug)  
Combination trigger (Single-set trigger / Direct trigger)

Karbonfaserverstärkter Lauf  
Carbon fibre reinforced barrel

ab / from  
€ 2.664,50



Mündungsgewinde: 1/2"-20 UNF  
Muzzle thread: 1/2"-20 UNF

Walnussholzschäft, Schweinsrücken - gerader Schäft  
Walnut stock, hogsback comb - straight stock



VOERE Tirolerin - Randfeuer mit Weaver-Schienen, Rotpunktvisier und VOERE End-Barrel Schalldämpfer  
VOERE Tirolerin - Rimfire with Weaver-rails, red dot sight and VOERE End-Barrel Suppressor

Walnussholzschäft, Monte Carlo  
Walnut stock, Monte Carlo

## TIROLERIN KLEINKALIBER WECHSELLAUFSYSTEM TIROLERIN KK-SWITCH BARREL SYSTEM

Durch Lauf-, Verschluss und Magazinwechsel ist ein modulares System von .22 lr. - 308 Win. möglich! Das System (2) bleibt für alle Kaliber dasselbe.

By changing barrel-, bolt and magazine, a modular system of .22 lr. - 308 Win. is possible! The action (2) remains the same for all calibres.



- 1 Verschluss - KK / Ranfeuer  
Bolt - Rimfire
- 2 System  
Action
- 3 Lauf - KK / Randfeuer  
Barrel - Rimfire
- 4 Abzug  
Trigger
- 5 Magazin Einsatz  
Magazine insert
- 6 Polymermagazin  
Polymer magazine

Preis auf Anfrage! / Price on request!  
(Art.Nr.: WA2006-01-A031)

## Mod. Tirolerin

NEW

<b>Länge / Length:</b>	ca. 99 cm		
<b>Gewicht / Weight:</b>	ca. 2,5 kg		
<b>Kaliber / Calibre:*</b> .22 lr.	<b>Drall / Twist:</b> 1:16"	<b>Lauf / Barrel:</b> 48 cm	<b>Magazin / Magazine:</b> 5-Schuss / 5-rounds
<b>Lauf / Barrel:</b>	Karbonfaserverstärkter Stahllauf (Ø 16 mm) / Carbon fibre reinforced steel barrel (Ø 16 mm)		
<b>Magazin / Magazine:</b>	5-Schuss Polymermagazin / 5-rounds polymer magazine		
<b>Abzug / Trigger:</b>	Kombiabzug (Rückstecher   Direktabzug) Combination trigger (Single-set trigger   Direct trigger)		
<b>Sicherung / Safety:</b>	2 Stellungen-Schlagbolzensicherung mit Kammersperre / 2-position firing pin safety with bolt lock		
<b>Schäft / Stock:</b>	Walnussholzschäft mit Doppelfalzbacke / Walnut stock with double groove cheek piece <b>Optional:</b> Walnussholzschäft mit Schweinsrücken / Walnut stock with hogsback comb		

\* Andere Kaliber auf Anfrage / Other calibres on request

(Art.Nr.: WA2006-00-0003)



## Mod. VICTOR 3 - RANDFEUER (LONGRANGE)

### Mod. VICTOR 3 - RIMFIRE (LONGRANGE)

Einteilige Aluminium Picatinny-Basis im System integriert (20 MOA)  
One-part Aluminium Picatinny-base integrated in the action (20 MOA)

ab / from  
€ 1.349,90

M-Lok Aufnahme für diverses Zubehör  
M-Lok mounts for various accessories

**VOERE VICTOR 3 - Randfeuer / Rimfire**  
(HERA-ARMS EDITION)

Mündungsgewinde: 1/2"-20 UNF  
Muzzle thread: 1/2"-20 UNF

AICS Magazineinsatz + 5-Schuss Polymermagazin  
AICS magazine insert + 5-rounds polymer magazine  
**STANDARD**

Matchdruckpunktanzug inkl. Finger-Stop  
Two-stage Match trigger incl. Finger-Stop  
**STANDARD**

Stahl Matchlauf, gehämmert (Ø 22 mm) - Hammeroberfläche sichtbar  
Steel Match-barrel, hammer forged (Ø 22 mm) - hammer surface visible

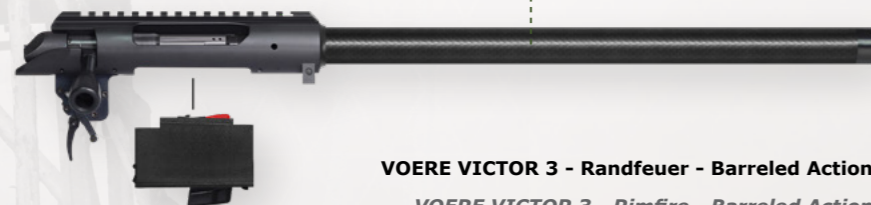

**VOERE VICTOR 3 - Randfeuer - Barreled Action**  
**VOERE VICTOR 3 - Rimfire - Barreled Action**

Preis auf Anfrage! / Price on request!

## Mod. VICTOR 3

**NEW**

<b>Länge / Length:</b>	ca. 92 cm		
<b>Gewicht / Weight:</b>	ca. 3,7 kg		
<b>Kaliber / Calibre:*</b>	<b>Drall / Twist:</b>	<b>Lauf / Barrel:</b>	<b>Magazin / Magazine:</b>
.22 lr.	1:16"	45 cm	5-Schuss / 5-rounds
<b>Lauf / Barrel:</b>	Stahl Matchlauf, gehämmert (Ø 22 mm) / Steel Match barrel, hammer forged (Ø 22 mm)		
<b>Magazin / Magazine:</b>	5-Schuss Polymermagazin + AICS Magazineinsatz / 5-rounds polymer magazine + AICS magazine insert		
<b>Abzug / Trigger:</b>	Matchdruckpunktanzug (MD) inkl. Finger-Stop (einstellbar) Two-stage Match trigger incl. Finger-Stop (adjustable)		
<b>Schaft / Stock:</b>	<b>HERA H7 Chassis</b> (System ist geeignet für alle Remington 700 SA Schäfte mit AICS Magazinaussparung.) (Action is suitable for all Remington 700 SA stocks with AICS magazine cutout).		

\* Andere Kaliber auf Anfrage / Other calibres on request

(Art.Nr.: WA2006-00-0003)

# SCHALLDÄMPFER SUPPRESSORS

## VOERE SCHALLDÄMPFER

Unsere VOERE Schalldämpfer zeichnen sich durch ihren vollkommen modularen Aufbau aus. Durch die Materialkombination aus Aluminium, Stahl und Karbon besitzen die Schalldämpfer eine äußerst hohe Dämpfungleistung. Unser Sortiment umfasst sowohl Jagd- als auch Sportschalldämpfer.

## VOERE SUPPRESSORS

*Our VOERE Suppressors are characterized by their completely modular design. The suppressors / silencers have an extremely high suppression performance due to their material combination of aluminium, steel and carbon. In our range are hunting-, sporting- and pistol suppressors.*

## VOERE SCHALLDÄMPFER-SERIE | VOERE SUPPRESSOR-SERIES

### END-BARREL SCHALLDÄMPFER | END-BARREL SUPPRESSORS

#### Der Dämpfer wird am Mündungsende befestigt.

- + Für große Distanzen und Sportschützen geeignet.
- + Für jedes Kaliber erhältlich.
- + Maximale Dämpfleistung auch für große Distanzen
- Bauart: sehr lange
- Schwerer als die anderen Varianten

#### The suppressor is mounted on the muzzle end.

- + Suitable for long distances and sport shooters.
- + For all calibres available.
- + Maximum suppression also for long distances.
- Construction: very long
- Heavier than the other versions



€ 289,-  
incl. Adapter

**END-BARREL SCHALLDÄMPFER** für Klein- und Schonzeitkaliber  
**END-BARREL SUPPRESSOR** for Rimfire- and Closed Season calibres  
(.22 Ir., 17 Rem., 222 Rem., 223 Rem., 300 AAC Blackout, etc.)

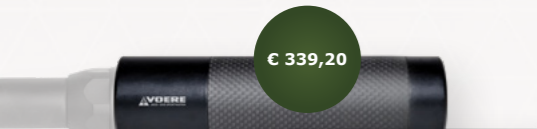

€ 339,20

**END-BARREL SCHALLDÄMPFER** mit Universal- oder Sportaufnahme  
**END-BARREL SUPPRESSOR** with Universal- or sporting device  
(Ideal für Kal. bis 7,62 / Ideal for cal. up to 7,62)



€ 407,-  
incl. Adapter

**END-BARREL SCHALLDÄMPFER** mit Universal- oder Sportaufnahme  
**END-BARREL SUPPRESSOR** with Universal- or sporting device  
(Ideal für Kal. bis 7,62 / Ideal for cal. up to 7,62)

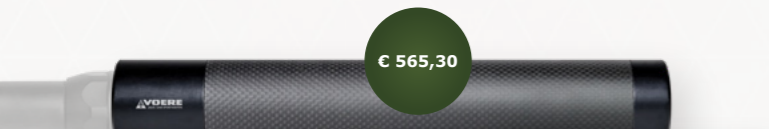

€ 565,30

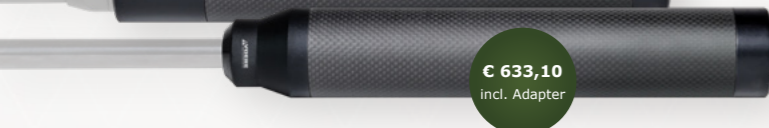

€ 633,10  
incl. Adapter

**END-BARREL SCHALLDÄMPFER** mit Sportaufnahme  
**END-BARREL SUPPRESSOR X5** with sporting device  
(Ideal für Kal. ab .416 / Ideal for cal. from .416)



€ 1.984,70



€ 339,20  
incl. Adapter

**PISTOLEN SCHALLDÄMPFER (Impulsschalldämpfer)** mit Universalaufnahme  
**PISTOL SUPPRESSOR (Impulse Suppressor)** with universal device  
(9 mm Luger, .45 Auto)

### OVER-BARREL SCHALLDÄMPFER | OVER-BARREL SUPPRESSORS

#### Der Dämpfer wird am Mündungsende befestigt.

- + Bauart: relativ kurz
- + Durch eine eingebaute Mündungsbremse wird auch der Rückstoß gedämpft.
- + Für mittlere Distanzen (200 m) geeignet.
- Wartungsintensiver - Häufigere Reinigung

#### The suppressor is mounted on the muzzle end.

- + Construction: relatively short
- + By the inserted muzzle brake also the recoil is dampened.
- + Suitable for medium distances (200 m).
- More maintenance-intensive - frequent cleaning



€ 467,70  
incl. Adapter

**JAGD OVER-BARREL SCHALLDÄMPFER**  
**HUNTING OVER-BARREL SUPPRESSOR**  
(Ideal für Kal. bis 7,62 / Ideal for cal. up to 7,62)

### INTEGRAL SCHALLDÄMPFER | INTEGRAL SUPPRESSORS

#### Der Dämpfer wird an der Laufwurzel befestigt.

- + Bauart: sehr kurz / Auch der Lauf ist kürzer.
- + Für Ultraschallmunition geeignet.
- Nur für kurze Distanzen (bis 100 m) geeignet.
- Durch das geringere Volumen ist die Kalibergröße nach oben begrenzt.

#### The suppressor is mounted on the barrel root.

- + Construction: very short / Also the barrel is shorter.
- + Suitable for subsonic ammunition.
- Only suitable for short distances (up to 100 m).
- Due to the smaller volume the calibre size is limited upwards.

**K15A/S16 mit INTEGRAL SCHALLDÄMPFER**  
**K15A/S16 with INTEGRATED SUPPRESSOR**  
(.22 Ir., 222 Rem., 223 Rem., 300 AAC Blackout, etc.)



ab / from  
€ 235,20

### INTEGRAL OVER-BARREL SCHALLDÄMPFER | INTEGRAL OVER-BARREL SUPPRESSORS

#### Kombination aus Integral- und Over-Barrel Dämpfer

- + Baut sehr kurz
- + Trotz kurzer Bauweise auch für größere Kaliber und mittlere Distanzen (200 m) geeignet.

#### Combination from Integral- and Over-Barrel Suppressor

- + Builds very short
- + Due to the short construction also suitable for larger calibres and medium distances (200 m).



ab / from  
€ 1.176,30

**INTEGRAL OVER-BARREL SCHALLDÄMPFER inkl. Lauf**  
**INTEGRAL OVER-BARREL SUPPRESSOR incl. barrel**  
(Ideal für Kal. ab 7,62 / Ideal for cal. from 7,62)

## VOERE JAGD END-BARREL SCHALLDÄMPFER VOERE HUNTING END-BARREL SUPPRESSORS



Montage Klemm-Adapter auf dem Visierbolzen  
Mounting clamp-adapter on the sight bolt

Montage Gewinde-Adapter auf Mündungsgewinde  
Mounting thread-adapter on muzzle thread

**1**  
Geeignet für Kaliber bis  
Suitable for calibre up to  
6,5 / .25  
C 67,80

Universalaufnahme  
Universal device

**KLEMM-ADAPTER / CLAMP-ADAPTER**

**2**  
C 67,80

**GEWINDE-ADAPTER / THREAD-ADAPTER**

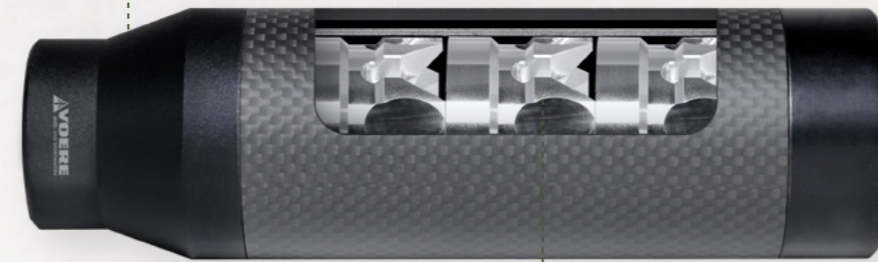

Dämpfung: 3 (165 mm) / 7 Blenden (273 mm)  
Suppression: 3 (165 mm) / 7 baffles (273 mm)

Speziell geeignet für Jagd-, Semi Weight- und Varmintläufe.  
Especially suitable for hunting-, semi-weight and varmint barrels.

Our modular **Hunting End-barrel Suppressors** with universal-device are available with a thread- or clamp-adapter, which can be easily interchanged.



**JAGD END-BARREL SCHALLDÄMPFER** (Ideal für Kaliber bis 7,62)  
**HUNTING END-BARREL SUPPRESSOR** (Ideal for calibre up to 7,62)

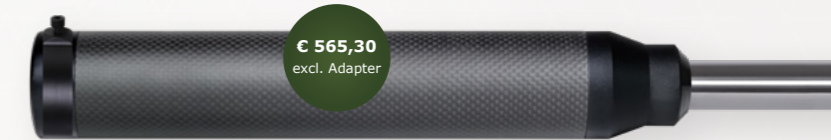

**JAGD END-BARREL SCHALLDÄMPFER** (Ideal für Kaliber ab 7,62)  
**HUNTING END-BARREL SUPPRESSOR** (Ideal for calibre from 7,62)

**1**  
**KLEMM-ADAPTER / CLAMP-ADAPTER**

- Klemm-Adapter + Ausgleichshülse  
Ø 15 mm | Ø 16 mm Jagdlauf
- Clamp-adapter + adjustment sleeve  
Ø 15 mm | Ø 16 mm hunting-barrel

Art.Nr.: WZSDPF-01-(A059/A060)

**2**  
**GEWINDE-ADAPTER / THREAD-ADAPTER**

- M17x1\*      • 1/2"-20 UNF\*
- M18x1\*\*    • 5/8"-24 UNEF\*\*
- M19x1\*      • 1/2"-28 UNEF\*
- M22x1,5\*    • 3/4"-24 UNS\*\*
- M24x1\*\*

Andere Gewinde auf Anfrage / Other threads on request  
Art.Nr.: WZSDPF-01-XY12

\* Jagdläufe - max. Ø 19 mm | Hunting barrels - max. Ø 19 mm  
\*\* Varmintläufe - max. Ø 24 mm | Varmint barrels - max. Ø 24 mm

### JAGD End-Barrel Schalldämpfer / HUNTING End-Barrel Suppressors

<b>Kaliber / Calibre:*</b>	.22   5,56 - .408   10,3
<b>Länge / Length:</b>	165 mm   273 mm
<b>Länge ab der Laufmündung: / Length from muzzle:</b>	140 mm (Gewinde-Adapter) / 123 mm (Klemm-Adapter)   140 mm (thread-adapter) / 123 mm (clamp-adapter) 248 mm (Gewinde-Adapter) / 231 mm (Klemm-Adapter)   248 mm (thread-adapter) / 231 mm (clamp-adapter)
<b>Gewicht / Weight:</b>	ca. 430 g (165 mm)   ca. 740 g (273 mm)
<b>Durchmesser / Diameter:</b>	Ø 48 mm
<b>Reduktion / Reduction:</b>	≥ 25 dB (c) (165 mm)   ≥ 30 dB (c) (273 mm) (abhängig von Kaliber, Munition, Messstelle, usw. / depending on calibre, ammunition, measurement point, barrel length, etc.)
<b>Material:</b>	Kombination aus Karbon, Stahl und Aluminium   Combination of carbon, steel and aluminium
<b>Dämpfung / Suppression:</b>	Austauschbare Blenden aus Aluminium oder Stahl (kaliberabhängig) Interchangeable aluminium or steel baffles (depending on calibre)

\*Bei Bestellung Kaliber angeben. / Please specify calibre when ordering.

Art.Nr.: WZSDPF-01-(A009-A014)

**Beispiel Bestellung:** 1. Kaliber / calibre + 2. Adapter + 3. Länge / length + 4. Abschluss / cover cap  
**Example order:** (z.B.: 6,5x55 SE) Klemm- oder Gewinde-Adapter (165 mm / 273 mm) (z.B.: Abschluss - Snaplock-Anbindung)  
Clamp- or thread-adapter (e.g.: Cover cap - Snaplock-connection)  
(z.B.: M15x1)

## VOERE SPORT END-BARREL SCHALLDÄMPFER VOERE TARGET END-BARREL SUPPRESSORS

Der Schalldämpfer wird über die VOERE Match Mündungsbremse (M18x1 links) montiert und dabei muss die Verschlusskappe abgenommen werden.

The suppressor is mounted on the VOERE Match muzzle brake (M18x1 left), while the cover cap must be removed.

Sportaufnahme für VOERE Match Mündungsbremse  
Sporting device for VOERE Match muzzle brake



Mantel aus Karbon  
Carbon outer jacket

Hülle aus Edelstahl  
Stainless steel case

Dämpfung: 3 (175 mm) oder 7 Blenden (283 mm)  
Suppression: 3 (175 mm) or 7 baffles (283 mm)

Blenden aus Aluminium oder Stahl (kaliberabhängig)  
Aluminium or steel baffles (depending on calibre)

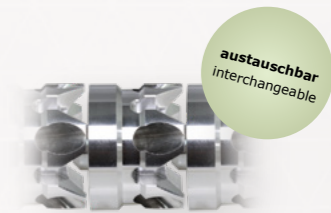

Blende (einzeln) / Baffle (single-part)

€ 34,- | Art.Nr.: WZSPDF-01-XY05

**BLENDEN / BAFFLES**

austauschbar / interchangeable

Reinigungsfähig / cleanable

Verschiedene Einsätze / different inserts

Material: Aluminium/Stahl / Material: aluminum/steel

**SPORT END-BARREL SCHALLDÄMPFER** (Ideal für Kaliber bis 7,62)  
**TARGET END-BARREL SUPPRESSOR** (Ideal for calibre up to 7,62)

€ 339,20  
incl. Adapter



**SPORT END-BARREL SCHALLDÄMPFER** (Ideal für Kaliber ab 7,62)  
**TARGET END-BARREL SUPPRESSOR** (Ideal for calibre from 7,62)

€ 565,30  
incl. Adapter



### SPORT END-BARREL Schalldämpfer / TARGET END-BARREL Suppressors

<b>Kaliber / Calibre:*</b>	.22   5,56 - .408   10,3
<b>Länge / Length:</b>	175 mm   283 mm
<b>Länge ab der Laufmündung: / Length from muzzle:</b>	108 mm   216 mm
<b>Gewicht / Weight:</b>	ca. 430 g (175 mm)   ca. 740 g (283 mm)
<b>Durchmesser / Diameter:</b>	Ø 48 mm
<b>Reduktion / Reduction:</b>	≥ 25 dB (c) (165 mm)   ≥ 30 dB (c) (273 mm) <small>(abhängig von Kaliber, Munition, Messstelle, usw. / depending on calibre, ammunition, measurement point, barrel length, etc.)</small>
<b>Material:</b>	Kombination aus Karbon, Stahl und Aluminium   Combination of carbon, steel and aluminium
<b>Dämpfung / Suppression:</b>	Austauschbare Blenden aus Aluminium oder Stahl (kaliberabhängig) Interchangeable aluminium or steel baffles (depending on calibre)

\*Bei Bestellung Kaliber angeben. / Please specify calibre when ordering.

Art.Nr.: WZSPDF-01-(A033-A038)

**Beispiel Bestellung:** 1. Kaliber / calibre + 2. Länge / length + 3. Abschluss / cover cap  
**Example order:** (z.B.: 308 Win.) 175 mm / 283 mm (z.B.: Abschluss - Flimmerband-Anbindung / Cover cap - Mirage-band-connection)

## VOERE END-BARREL SCHALLDÄMPFER SET (JAGD | SPORT) VOERE END-BARREL SUPPRESSOR SET (HUNTING | TARGET)



Transportkoffer / Transport case

1x Klemm-Adapter + Ausgleichshülsen  
(Ø 15 mm / Ø 16 mm)  
1x clamp-adapter + adjustment sleeves  
(Ø 15 mm / Ø 16 mm)

- 9x Gewinde-Adapter  
9x thread-adapter
- 1/2"-20 UNF • M16x1
  - M13x1 • M17x1
  - M13,5x1 • M18x1
  - M14x1 • M19x1
  - M15x1

Biteinsatz zum Zerlegen des Schalldämpfers  
Bit insert for disassembling of the suppressor

**VOERE End-Barrel Schalldämpfer** mit Blenden in den Kalibern 5,56 - 10,3 mit Universal- oder Sportaufnahme

**VOERE End-Barrel Suppressor** with baffles in the calibres 5,56 - 10,3 with universal- or sporting device

**VOERE End-Barrel Schalldämpfer** mit Blenden in den Kalibern 5,56 - 10,3 mit Universal- oder Sportaufnahme

**VOERE End-Barrel Suppressor** with baffles in the calibres 5,56 - 10,3 with universal- or sporting device

Art.Nr.: WZSDPF-01-A101

## VOERE SPORT END-BARREL SCHALLDÄMPFER X5 VOERE TARGET END-BARREL SUPPRESSOR X5

Geeignet für Matchläufe mit VOERE Taktischer Match Mündungsbremse mit 2 Kammern.  
Suitable for Match barrels with VOERE Tactical Match muzzle brake with 2 chambers.



Bis Kaliber 50 Browning geeignet.  
Suitable up to calibre 50 Browning.

Kühlkanäle zur Selbstreinigung  
Cooling channels for self cleaning

In 3D-Metalldruck Technik gefertigt.  
Produced with 3D-metal printing technology.

VOERE Taktische Match Mündungsbremse mit 2 Kammern  
VOERE Tactical Match muzzle brake with 2 chambers

### SPORT END-BARREL Schalldämpfer X5 / TARGET END-BARREL Suppressor X5

<b>Kaliber / Calibre:*</b>	.338   8,5 - .50   12,7
<b>Länge / Length:</b>	322 mm
<b>Länge ab der Laufmündung: / Length from muzzle:</b>	216 mm
<b>Gewicht / Weight:</b>	ca. 1600 g
<b>Durchmesser / Diameter:</b>	Ø 68 mm
<b>Reduktion / Reduction:</b>	≥ 27 dB (c) (abhängig von Kaliber, Munition, Messstelle, usw. / depending on calibre, ammunition, measurement point, barrel length, etc.)
<b>Material:</b>	Edelstahl / Stainless Steel

\*Bei Bestellung Kaliber angeben. / Please specify calibre when ordering.

Art.Nr.: WZSDPF-01-A063

## VOERE JAGD END-BARREL SCHALLDÄMPFER VOERE HUNTING END-BARREL SUPPRESSOR

Geeignet für Jagdläufe (Karbon) für Klein- und Schonzeitkaliber.  
Suitable for hunting barrels (carbon) for small bore- and closed season calibres.



JAGD END-BARREL Schalldämpfer / HUNTING END-BARREL Suppressor	
<b>Kaliber / Calibre:*</b>	Klein- und Schonzeitkaliber / Small bore- and closed season calibres
<b>Länge / Length:</b>	190 mm
<b>Länge ab der Laufmündung: / Length from muzzle:</b>	165 mm (Gewinde am Lauf) / 155 mm (VOERE Edelstahl Mündungsbremse) 165 mm (Barrel thread) / 155 mm (VOERE Stainless steel Muzzle Brake)
<b>Gewicht / Weight:</b>	ca. 420 g
<b>Durchmesser / Diameter:</b>	Ø 40 mm
<b>Reduktion / Reduction:</b>	≥ 25 dB (c) <small>(abhängig von Kaliber, Munition, Messstelle, Lauflänge, etc. / depending on calibre, ammunition, measurement point, barrel length, etc.)</small>
<b>Material:</b>	Kombination aus Stahl und Aluminium   Combination of steel and aluminium
<b>Dämpfung / Suppression:</b>	Austauschbare Blenden aus Aluminium oder Stahl (kaliberabhängig) Interchangeable aluminium or steel baffles (depending on calibre)

\*Bei Bestellung Kaliber angeben. / Please specify calibre when ordering.

Art.Nr.: WZSDPF-01-(A080-A081)

## VOERE PISTOLEN SCHALLDÄMPFER (Impuls Schalldämpfer) VOERE PISTOL SUPPRESSOR (Impulse Suppressor)

### Impuls Schalldämpfer:

Die Anbindung des Schalldämpfer entkoppelt dessen Gewicht von Lauf um eine zuverlässige Funktion zu garantieren.

### Impulse Suppressor:

The connection of the suppressor decouples its weight from the barrel to guarantee reliable function.



Pistolen Schalldämpfer / Pistol Suppressor	
<b>Kaliber / Calibre:*</b>	9 mm Luger   .45 Auto
<b>Länge / Length:</b>	190 mm
<b>Länge ab der Laufmündung: / Length from muzzle:</b>	165 mm
<b>Gewicht / Weight:</b>	ca. 420 g
<b>Durchmesser / Diameter:</b>	Ø 40 mm
<b>Reduktion / Reduction:</b>	≥ 25 dB (c) <small>(abhängig von Kaliber, Munition, Messstelle, Lauflänge, etc. / depending on calibre, ammunition, measurement point, barrel length, etc.)</small>
<b>Material:</b>	Kombination aus Stahl und Aluminium   Combination of steel and aluminium
<b>Dämpfung / Suppression:</b>	Austauschbare Blenden aus Aluminium Interchangeable aluminium baffles

\*Bei Bestellung Kaliber angeben. / Please specify calibre when ordering.

Art.Nr.: WZSDPF-01-(A082-A087)

## VOERE JAGD OVER-BARREL SCHALLDÄMPFER VOERE HUNTING OVER-BARREL SUPPRESSOR

Geeignet für Jagd- (Karbon) und Semi Weight Läufe bis Laufdurchmesser Ø 20 mm.  
Suitable for hunting (carbon) and semi-weight barrels up to barrel diameter Ø 20 mm.



**Abschlüsse Schalldämpfer / Cover Caps Suppressors**  
End-Barrel Schalldämpfer / Over-Barrel Schalldämpfer / Integral Over-Barrel Schalldämpfer  
End-Barrel Suppressor / Over-Barrel Suppressor / Integral Over-Barrel Suppressor

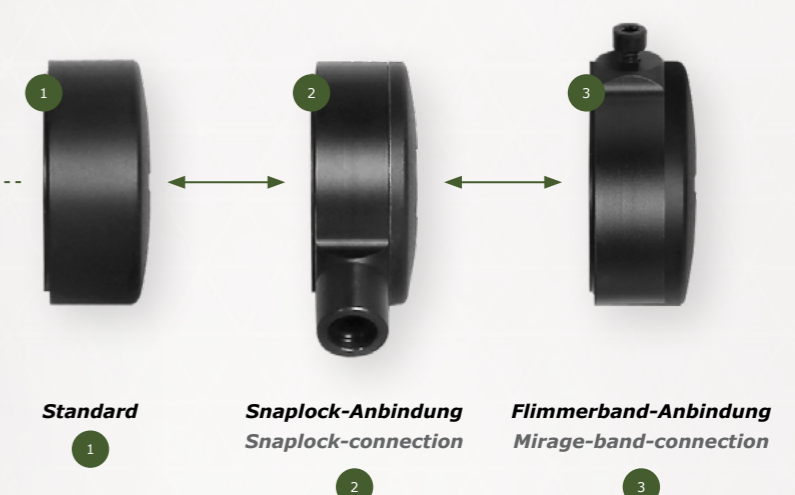

VOERE Edelstahl Mündungsbremse (M18x1)  
VOERE Stainless steel Muzzle Brake (M18x1)

Mündungsgewinde (Gewinde-Adapter)  
Muzzle thread (thread-adapter)

Gewinde-Adapter / Thread-Adapter:  
M13x1 | M13,5x1 | M14x1 | M15x1 | M16x1 | M17x1 | M18x1 | M19x1  
M22x1,5 | 1/2"-20 UNF | 5/8"-24 UNEF | 1/2"-28 UNEF | 3/4"-24 UNS  
**Andere Gewinde auf Anfrage! Other threads on request!**

**€ 467,70**  
incl. Adapter

Jagd Over-Barrel Schalldämpfer / Hunting Over-Barrel Suppressor	
<b>Kaliber / Calibre:*</b>	.22   5,56 - .408   10,3
<b>Länge / Length:</b>	198 mm
<b>Länge ab der Laufmündung: / Length from muzzle:</b>	130 mm (Gewinde am Lauf) / 92 mm (VOERE Edelstahl Mündungsbremse) 130 mm (barrel thread) / 92 mm (VOERE Stainless steel Muzzle Brake)
<b>Gewicht / Weight:</b>	ca. 490 g
<b>Durchmesser / Diameter:</b>	Ø 48 mm
<b>Reduktion / Reduction:</b>	≥ 27 dB (c) <small>(abhängig von Kaliber, Munition, Messstelle, Lauflänge, etc. / depending on calibre, ammunition, measurement point, barrel length, etc.)</small>
<b>Material:</b>	Kombination aus Karbon, Stahl und Aluminium   Combination of carbon, steel and aluminium
<b>Dämpfung / Suppression:</b>	Austauschbare Blenden aus Aluminium oder Stahl (kaliberabhängig) Interchangeable aluminium or steel baffles (depending on calibre)

**Beispiel Bestellung:** 1. Kaliber / calibre + 2. Gewinde-Adapter + 3. Abschluss / cover cap  
**Example order:** (z.B.: 308 Win.) (z.B.: M18x1) (z.B.: Abschluss - Standard / Cover cap - Standard)

\*Bei Bestellung Kaliber angeben. / Please specify calibre when ordering. Art.Nr.: WZSDPF-01-(A073-A078)

## INTEGRAL OVER-BARREL SCHALLDÄMPFER INTEGRAL OVER-BARREL SUPPRESSOR

Geeignet für VOERE Modelle LBW / M2 / VICTOR 3.  
Suitable for Models LBW / M2 / VICTOR 3.



**Abschlüsse Schalldämpfer / Cover cap Suppressor**  
Standard / Flimmerband-Anbindung / Snaplock-Anbindung  
Standard / Mirage-band-connection / Snaplock-connection

Integral Over-Barrel Schalldämpfer / Integral Over-Barrel Suppressor	
<b>Kaliber / Calibre:*</b>	<b>308 Win.</b>
<b>Länge / Length:</b>	Laufänge: 395 mm   Barrel length: 395 mm Länge Schalldämpfer: 255 mm   Length Suppressor: 255 mm Gesamtlänge: 550 mm   Overall length: 550 mm
<b>Gewicht / Weight:</b>	ca. 1400 g (Integral Schalldämpfer inkl. Lauf / Integrated Suppressor incl. barrel)
<b>Durchmesser / Diameter:</b>	Ø 48 mm
<b>Reduktion / Reduction:</b>	≥ 28 dB (c) <small>(abhängig von Kaliber, Munition, Messstelle, Laufänge, etc. / depending on calibre, ammunition, measurement point, barrel length, etc.)</small>
<b>Material:</b>	Kombination aus Karbon, Stahl und Aluminium   Combination of carbon, steel and aluminium
<b>Dämpfung / Suppression:</b>	Austauschbare Blenden aus Aluminium oder Stahl (kaliberabhängig) Interchangeable aluminium or steel baffles (depending on calibre)

\* Andere Kaliber auf Anfrage / Other calibres on request

Art.Nr.: WZSDPF-01-A0..

## VOERE K15A - INTEGRAL SCHALLDÄMPFER VOERE K15A - INTEGRAL SUPPRESSOR



## VOERE S16 - INTEGRAL SCHALLDÄMPFER VOERE S16 - INTEGRAL SUPPRESSOR



K15A - Integral Schalldämpfer   K15A - Integral Suppressor	
<b>Kaliber / Calibre:</b> *	.22 lr.
<b>Länge / Length:</b>	420 mm
<b>Gewicht / Weight:</b>	ca. 320 g
<b>Durchmesser / Diameter:</b>	Ø 25 mm
<b>Reduktion / Reduction:</b>	≥ 28 dB (c) <small>(abhängig von Kaliber, Munition, Messstelle, Lauflänge, etc. / depending on calibre, ammunition, measurement point, barrel length, etc.)</small>
<b>Material:</b>	Aluminium und Stahl / Aluminium and steel
<b>Dämpfung / Suppression:</b>	Austauschbarer Monolith aus Aluminium / Interchangeable aluminium monolith

\* Andere Kaliber auf Anfrage / Other calibres on request

Art.Nr.: WZSDPF-01-A008

S16 - Integral Schalldämpfer   S16 - Integral Suppressor	
<b>Kaliber / Calibre:</b> *	222 Rem. / 223 Rem. / 300 AAC Blackout
<b>Länge / Length:</b>	420 mm
<b>Gewicht / Weight:</b>	ca. 340 g
<b>Durchmesser / Diameter:</b>	Ø 25 mm
<b>Reduktion / Reduction:</b>	≥ 28 dB (c) <small>(abhängig von Kaliber, Munition, Messstelle, Lauflänge, etc. / depending on calibre, ammunition, measurement point, barrel length, etc.)</small>
<b>Material:</b>	Aluminium und Stahl / Aluminium and steel
<b>Dämpfung / Suppression:</b>	Austauschbare Blenden aus Aluminium / Interchangeable aluminum baffles

\* Andere Kaliber auf Anfrage / Other calibres on request

Art.Nr.: WZSDPF-01-A066

## VOERE PET-FLASCHEN ADAPTER FÜR REINIGUNGSZWECKE

### VOERE PET-BOTTLE ADAPTER FOR CLEANING PURPOSES

PET-Flaschen auf der Mündung aufgesetzt, werden für die Dämpfung von freien Waffen (z.B. Luftdruckgewehre) benutzt. Bei Großkalibergewehren kann die PET-Flasche als Reinigungshilfe Verwendung finden. Der PET-Flaschen Adapter wird mit Hilfe unserer Gewinde-Adapter auf die Flasche bzw. auf den Lauf der Waffe geschraubt.

*PET-bottles placed on the muzzle are used for the suppression of free weapons (e.g. air rifles) By large calibre rifles, the PET-bottle can be used as a cleaning aid. The PET-bottle adapter is screwed onto the bottle or the barrel of the weapon with our thread-adapter.*

#### PET-Flaschen-Adapter mit Gewinde-Adapter (Jagd / Varmint / Match)

*PET-Bottle-Adapter with Thread-Adapter (Hunting / Varmint / Match)*



#### PET-Flaschen-Adapter mit Gewinde-Adapter für Pistolen

*PET-Bottle-Adapter with Thread-Adapter for pistols*



## 10 VORTEILE VOERE SCHALLDÄMPFER-SERIE

### 10 ADVANTAGES VOERE SUPPRESSOR-SERIES

- 1** **"VOERE SCHALLDÄMPFER"**- Für jede Anwendung (Jagd/Sport) der passende Schalldämpfer.  
(End-Barrel SD / Over-Barrel SD / Integral SD / Integral Over-Barrel SD / PET-Flaschen Adapter / Pistolen SD)
- "VOERE SUPPRESSORS"**- The right suppressor for every application (hunting/sporting).  
(End-Barrel SD / Over-Barrel SD / Integral SD / Integral Over-Barrel SD / PET-bottle adapter / Pistol SD)
- 2** Doppelkammersystem / Stahlbauweise | *Double chamber system / steel construction*
- 3** Doppelwandig für bessere Schützensicherheit, Wärmeableitung, geringere Hitzeentwicklung  
*Double-walled for better protection, heat dissipation, less heat generation*
- 4** Der passende Schalldämpfer für jedes Kaliber. (5,56/.22 - 12,7/.50)  
*The right suppressor for every calibre. (5,56/.22 - 12,7/.50)*
- 5** Lange Lebensdauer durch hohe Modularität | *Long life due to high modularity*
- 6** Hohe Dämpfleistungen durch Materialkombination (Karbon / Stahl / Aluminium)  
*High suppression performance through material combination (carbon / steel / aluminium)*
- 7** Massive und kompakte Bauweise | *Solid and compact construction*
- 8** Reduzierter Rückstoß | *Reduced muzzle flash*
- Verringertes Mündungsfeuer | *Reduced recoil*
- 10** Für Magnum Kaliber geeignet. | *Suitable for magnum calibres.*

## MÜNDUNGSBREMSEN | MUZZLE BRAKES

Viele unserer Modelle verfügen über eine Mündungsbremse, welche im Nachhinein getauscht oder erneuert werden kann.

Unsere Mündungsbremsen werden aus hochwertigen Materialien gefertigt. Sie eignen sich für große als auch kleine Kaliber und zeichnen sich durch ihre Effizienz und Bewährtheit aus. (Rückstoßdämpfung - ca. 33%).

*Many of our models have a muzzle brake, which can be replaced or renewed retrospectively.*

*Our muzzle brakes are made with high quality materials suitable for large and small calibres as well. They are characterized by their efficiency and reliability.*

*(recoil absorption - approx. 33%).*

## JAGD-, VARMINT MÜNDUNGSBREMSEN | HUNTING-, VARMINT MUZZLE BRAKES

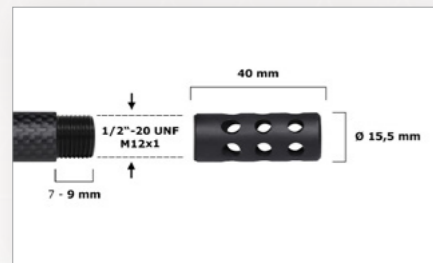

### Jagdmündungsbremse Hunting Muzzle Brake

Kaliber: Klein- und Schonzeitkaliber  
Calibre: Small-Bore and Closed Season calibres

€ 74,90

Art.Nr.: WA2016-01-(0005/0018)

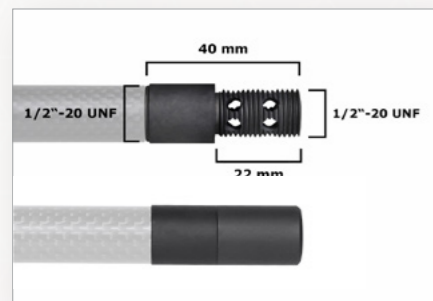

### Jagdmündungsbremse mit Gewinde Hunting Muzzle Brake with thread

Kaliber: Klein- und Schonzeitkaliber  
Calibre: Small-Bore and Closed Season calibres

€ 74,90

Art.Nr.: WA2016-(B001/B002)

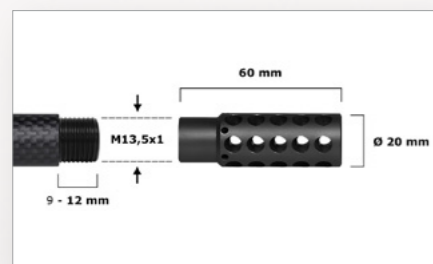

### Titan Mündungsbremse für Jagdläufe Titan Muzzle Brake for Hunting-Barrels

Kaliber: 222 Rem. - 338 Lapua Mag.  
Calibre: 222 Rem. - 338 Lapua Mag.

€ 128,30

Art.Nr.: WZMÜBR-01-(0001-0003)

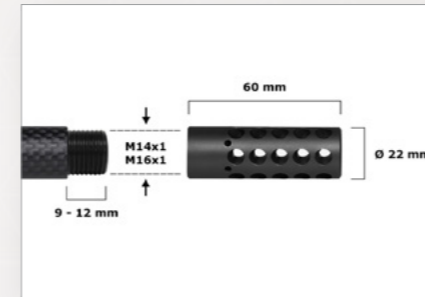

### Titan Mündungsbremse für Varmintläufe Titan Muzzle Brake for Varmint-barrels

Kaliber: 222 Rem. - 338 Lapua Mag.  
Calibre: 222 Rem. - 338 Lapua Mag.

€ 128,30

Art.Nr.: WZMÜBR-01-(0004-0006)

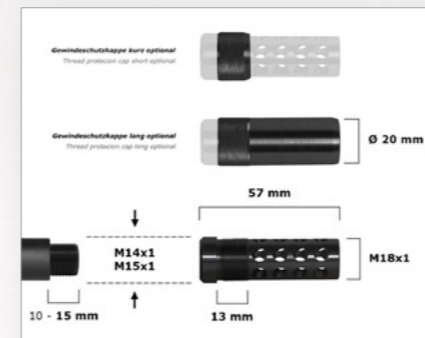

### Edelstahl Mündungsbremse für Jagdläufe Stainless steel Muzzle Brake for Hunting-barrels

Kaliber: 222 Rem. - 338 Lapua Mag.  
Calibre: 222 Rem. - 338 Lapua Mag.

€ 139,10

Art.Nr.: WZMÜBR-01-(0019/0025)

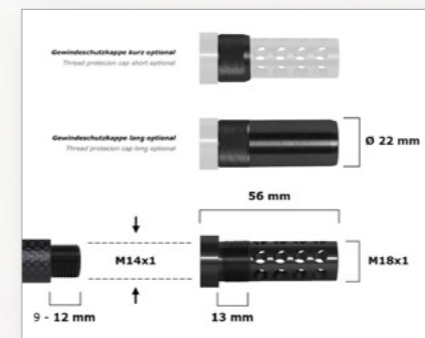

### Edelstahl Mündungsbremse für Varmintläufe Stainless steel Muzzle Brake for Varmint-barrels

Kaliber: 222 Rem. - 338 Lapua Mag.  
Calibre: 222 Rem. - 338 Lapua Mag.

€ 139,10

Art.Nr.: WZMÜBR-01-0024

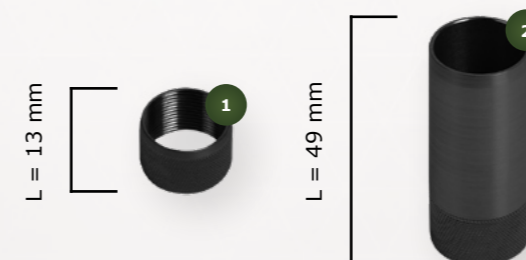

1 | Schutzkappe, gerändelt Ø 20 mm  
Protection cap, curled Ø 20 mm

€ 10,70 | Art.Nr.: WZMÜBR-01-0026

2 | Schutzkappe, gerändelt Ø 20 mm  
Protection cap, curled Ø 20 mm

€ 21,40 | Art.Nr.: WZMÜBR-01-0027

## TAKTISCHE MATCH MÜNDUNGSBREMSEN TACTICAL MATCH MUZZLE BRAKES

**Taktische Match Mündungsbremse mit 3 Kammern** (Ideal für Kaliber bis .408)  
*Stainless steel Match muzzle brake with 3 chambers* (Ideal for calibre up to .408)

- Anbindung für Schalldämpfer
- Kaliber: 222 Rem. - 408 CT
- 3-Kammernsystem
- Anbindung für Flimmerband
- Connection for suppressors
- Calibre: 222 Rem. - 408 CT
- 3-chamber system
- Connection for mirage band

€ 342,20

(Art.Nr.: WZMÜBR-01-(0009/0010/0011)

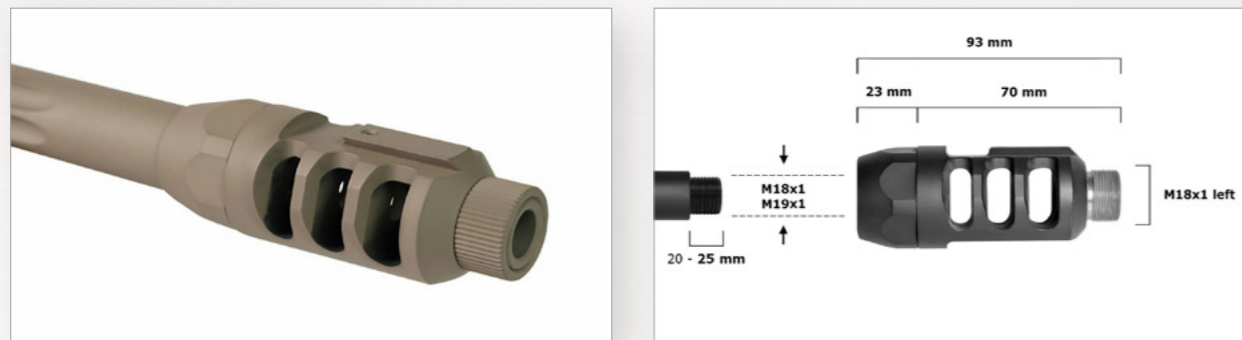

**Taktische Match Mündungsbremse mit 2 Kammern** (Ideal für Kaliber ab .416)  
*Tactical Match muzzle brake with 2 chambers* (Ideal for calibre up to .416)

- Anbindung für Schalldämpfer
- 2-Kammernsystem
- Anbindung für Flimmerband
- Kaliber: 308 Win. - 50 Browning
- Connection for suppressors
- 2-chamber system
- Connection for mirage band
- Calibre: 308 Win. - 50 Browning

€ 353,-

(Art.Nr.: WZMÜBR-01-B001)

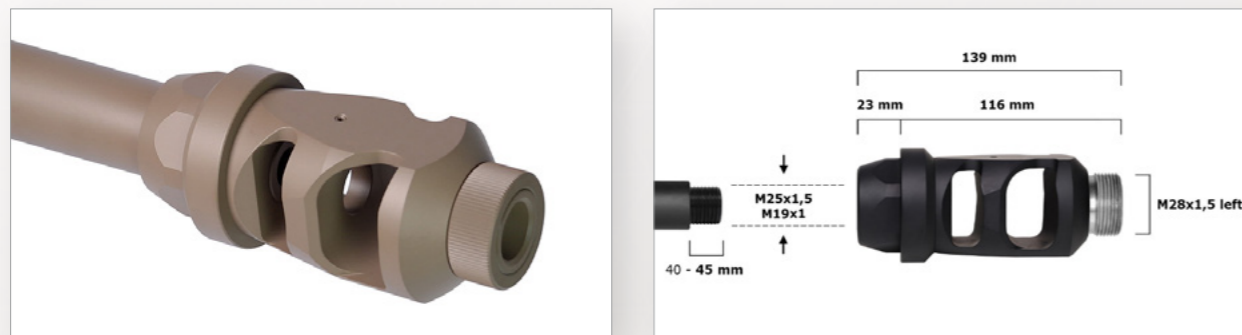

## MÜNDUNGSFEUERDÄMPFER | SIGNATURDÄMPFER BLAST DEFLECTOR

Durch den Mündungsfeuerdämpfer werden Mündungsgase gebremst und seitliches Austreten verhindert.

Through the blast deflector muzzle gases are slowed down and lateral leakage will be prevented.

**Mündungsfeuerdämpfer für Taktische Match Mündungsbremse mit 3 Kammern**  
*Blast Deflector for Tactical Match muzzle brake with 3 chambers*

- Kaliber: 222 Rem. - 408 CT
- Optional: Flimmerband-Anbindung
- Snaplock-Anbindung
- Calibre: 222 Rem. - 408 CT
- Optional: Mirage-band connection
- Snaplock-connection

€ 120,-

(Art.Nr.: WZSDPF-01-(A065/A065))



VOERE X3 in flat dark earth mit Zubehör  
VOERE X3 in flat dark earth with accessories



## MÜNDUNGSSCHUTZ | MUZZLE PROTECTION

**Schutzkappe Ø 18 mm**  
*Protection cap Ø 18 mm*  
(M14x1 | M15x1 | M16x1)



€ 6,40

Art.Nr.: WZSDPF-01-(0053/0054/0055)

**Schutzkappe Ø 21 mm**  
*Protection cap Ø 21 mm*  
(M14x1 | M15x1 | M16x1 | M18x1)



€ 6,40

Art.Nr.: WZSDPF-01-(0056/0057/0058/0059)

**Mündungsschutz Ø 23 mm**  
*Muzzle protection Ø 23 mm*  
(M18x1 | M19x1)



€ 17,20

Art.Nr.: WZMÜBR-01-(0013/0014)

**Mündungsschutz Ø 15 mm**  
*Muzzle protection Ø 15 mm*  
(M14x1)



€ 10,70

Art.Nr.: WZMÜBR-01-0021

**Mündungsschutz Ø 16 mm**  
*Muzzle protection Ø 16 mm*  
(M14x1 | M15x1)



€ 10,70

Art.Nr.: WZMÜBR-01-(0017/0022)

**Mündungsschutz Ø 17 mm**  
*Muzzle protection Ø 17 mm*  
(M13,5x1)



€ 10,70

Art.Nr.: WZMÜBR-01-0007

**Mündungsschutz, gerändelt Ø 17 mm**  
*Muzzle protection, knurled Ø 17 mm*  
(M13,5x1)



€ 10,70

Art.Nr.: WZMÜBR-01-0020

**Mündungsschutz Ø 23 mm**  
*Muzzle protection Ø 23 mm*  
(M14x1)

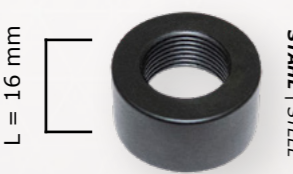

€ 10,70

Art.Nr.: WZMÜBR-01-0016

**Mündungsschutz Ø 15 mm**  
*Muzzle protection Ø 15 mm*  
(1/2"-20 UNF)



€ 6,40

Art.Nr.: WA2015-01-0008

**Schutzkappe Ø 19/21/24 mm**  
*Protection cap Ø 19/21/24 mm*  
(1/2"-20 UNF)

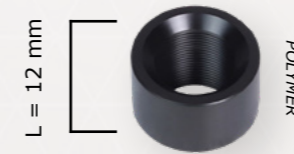

€ 10,70

Art.Nr.: WA2021-01-(0026/0027/0028)

**Schutzkappe Ø 27/29 mm**  
*Protection cap Ø 27/29 mm*  
(M19x1)

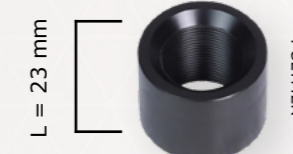

€ 10,70

Art.Nr.: WA2021-01-(0024/0025)

**Schutzkappe Ø 32 mm**  
*Protection cap Ø 32 mm*  
(M18x1)



€ 10,70

Art.Nr.: WA2021-01-0034

**Mündungsschutz Ø 15,6 mm**  
*Protection cap Ø 15,6 mm*  
(1/2"-20 UNF)



€ 6,40

Art.Nr.: WA2016-01-0026

**Schutzkappe, gerändelt Ø 20 mm**  
*Protection cap, curled Ø 20 mm*  
(M18x1)



€ 10,70

Art.Nr.: WZMÜBR-01-0026

**Schutzkappe, gerändelt Ø 20 mm**  
*Protection cap, curled Ø 20 mm*  
(M18x1)

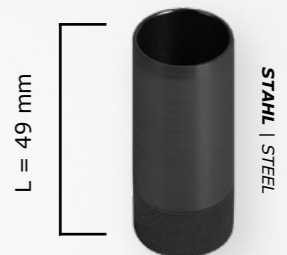

€ 21,40

Art.Nr.: WZMÜBR-01-0027

**Mündungsschutz Ø 23 mm**  
*Protection cap Ø 23 mm*  
(M18x1 left)

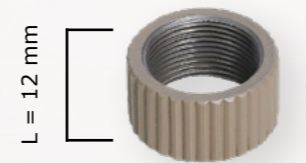

€ 21,40

Art.Nr.: WA2009-01-0009

**Adapter für Gewinde**  
*Adapter for threads*  
(M19x1 → M18x1)



€ 34,20

Art.Nr.: WA2009-01-0035

**Adapter für Gewinde**  
*Adapter for threads*  
(M12x1 → 1/2"-20 UNF)



€ 17,20

Art.Nr.: WA2016-01-0027

# ZUBEHÖR | ACCESSORY

## VOERE ZUBEHÖR

### HOCHWERTIG - ROBUST - BEWÄHRT

Durch unsere jahrelange Erfahrung in der Waffenbranche haben wir das passende Zubehör für all Ihre Bedürfnisse.

Zu unserem Zubehör gehören Mündungsbremsen, Montagen, Abzüge, Gewehrtaschen, Wechselläufe, Magazine und vieles mehr.

## VOERE ACCESSORY

### HIGH-QUALITY - ROBUST - RELIABLE

*Through our years of experience in the rifle industry, we have the rifle accessories for all your needs.*

*Our accessory includes mounts, triggers, muzzle brakes, bipods, rifles bags, interchangeable barrels, magazines and many more.*

### Org. Flügelsicherung Org. wing-type safety



Standard  
Mod. 2155

(Art.Nr.: WA2155-09-A003)

### Kolbenhalsssicherung Top tang safety (slide safety)



Standard  
Mod. 2165

(Art.Nr.: WA2165-09-A002)

### Handspannung mit / ohne Kammersperre Manual cocking safety with / without bolt lock



ab / from  
€ 213,90

Art.Nr.: WZ98SH-00-(0001/0002)

### Drehflügelsicherung mit / ohne Hebelsicherung 3-position safety with / without catch



ab / from  
€ 128,30

Art.Nr.: WA2155-09-(A001/A002)

## K98 ZUBEHÖR | M98 ACCESSORY

### K98 Ersatzteile

Sicherungen, Abzüge, Magazine, Kammergriffe und Visierungen für Reparaturen oder Aufrüstungen

### M98 Spare Parts

Spare magazines, triggers, safeties, handles and sights for repair or upgrade



1 | Kammergriff unbearbeitet, flach  
Bolt handle unprocessed, flat

€ 21,40 | Art.Nr.: WA2155-03-0020



2 | Kammergriff unbearbeitet mit Rändel  
Bolt handle unprocessed with knurl

€ 21,40 | Art.Nr.: WA2155-03-0021



3 | Kammergriff unbearbeitet, gerade  
Bolt handle unprocessed, straight

€ 25,70 | Art.Nr.: WA2155-03-0022

Picatinny- / Weaver-Schienen und Basenplatten  
Picatinny- / Weaver-rails and Base plates



VOERE 2155 mit Nussholzstock, geölt  
VOERE 2155 with walnut stock, oiled

### Kaliber / Calibres:

6,5x55 SE / 6,5 Creedmoor  
6,5x57 / 6,5x68 / 7x57 / 7x64  
7mm Rem. Mag. 8x57 IS / 8x68 S  
9,3x62 / 25-06 Rem. / 22-250 Rem.  
243 Win. / 270 Win. / 308 Win.  
30-06 Spring. / 300 Win. Mag.



€ 158,20

### Umrüstsatz Magazinkasten für Einsteckmagazin Detachable magazine conversion kit

3/5-Schuss (Standard) / 2/4-Schuss (Magnum)  
3/5-rounds (Standard) / 2/4-rounds (Magnum)

Art.Nr.: WA2155-07-(A002/A003)



€ 158,20

### Aluminium Klappdeckelmagazin Aluminium drop box magazine kit

4-Schuss (Standard) / 3-Schuss (Magnum)  
4-rounds (Standard) / 3-rounds (Magnum)

Art.Nr.: WA2155-07-A001)

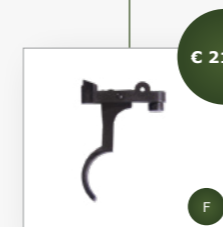

€ 21,40

F

Org. Druckpunktanzug  
Org. Two-stage trigger  
(Art.Nr.: WA2155-04-A001)



€ 115,50

ST

Deutscher Stecher  
Double-set trigger  
(Art.Nr.: WA2155-04-A004)

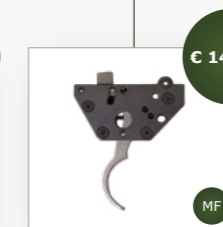

€ 149,70

MF

Direktanzug  
Direct trigger  
(Art.Nr.: WA2155-04-A008)



€ 149,70

RST

Rückstecher  
Single-set trigger  
(Art.Nr.: WA2155-04-A003)



€ 181,90

MD

Matchdruckpunktanzüge  
Two-stage Match triggers  
(Art.Nr.: WA2003-04-A00.)

Wir führen ein großes Sortiment an Abzügen mit K98-Aufhängungen für Jagd- und Sportschützen. Jeder unsere Abzüge ist universell einstellbar und für jedes K98-System passend.

We offer a wide variety of triggers for hunting and sporting rifles with M98 housing. All our triggers are universal adjustable and possible for every M98-Action.

## PICATINNY- UND WEAVER-SCHIENEN PICATINNY- AND WEAVER-RAILS

Unsere VOERE Picatinny- und Weaver-Schienen und Montagen aus eigener Produktion zeichnen sich durch ihre einfache Handhabung, Robustheit und vielseitige Kombierbarkeit aus. Diese sind für unterschiedliche Zieleinrichtungen geeignet, ohne Präzisionsverlust einwechselbar und mit über 20.000 Schusszyklen erprobt.

*Our VOERE Picatinny- and Weaver rails and mounts from our own production are characterized by their ease of use, robustness and versatile compatibility. They are suitable for different scope mounts, can be exchanged without lose of precision and are tested with over 20,000 firing cycles.*

## VERSTELLBARE PICATINNY-SCHIENE FÜR HÖCHSTE DISTANZEN ADJUSTABLE PICATINNY-RAIL FOR HIGHEST DISTANCES

- Picatinny-Schiene geeignet für Modelle LBW / M2 / X3.
- Material: Aluminium
- 2 Skalen (MOA / MIL)
- Verstellbereich (10 MOA - 171,9 MOA / 2,9 MIL - 50 MIL)
- Anbindung für Flimmerband

- *Picatinny-rail suitable for Models LBW / M2 / X3.*
- *Material: Aluminium*
- *2 scales (MOA / MIL)*
- *Adjustment range (10 MOA - 170 MOA / 2.9 MIL - 50 MIL)*
- *Connection for mirage-band*

(Art.Nr.: WZZFWE-11-A004)

## STAHL PICATINNY-SCHIENEN | STEEL PICATINNY-RAILS



Stahl Picatinny-Schienen für Mod. LBW/S16/M2/X3 Steel Picatinny-rails for Mod. LBW/S16/M2/X3		
0 MOA	8 mm Höhe   8 mm high	Art.Nr.: WZZFWE-11-A031
20 MOA	8 mm Höhe   8 mm high	Art.Nr.: WZZFWE-11-A034
30 MOA	8 mm Höhe   8 mm high	Art.Nr.: WZZFWE-11-A035
40 MOA	8 mm Höhe   8 mm high	Art.Nr.: WZZFWE-11-A036
0 MOA*	11,5 mm Höhe   11.5 mm high	Art.Nr.: WZZFWE-11-A032
0 MOA*	20 mm Höhe   20 mm high	Art.Nr.: WZZFWE-11-A037

\*Material: Edelstahl / Material: Stainless steel

Aufpreis Cerakote Beschichtung / Surcharge Cerakote coating (armor black, coyote tan, flat dark, tactical grey)

€ 21,40



Picatinny-Schiene - Erste Position  
Picatinny-rail - First position  
(10 MOA | 2,9 MIL)



Picatinny-Schiene - Letzte Position  
Picatinny-rail - Last position  
(171,9 MOA | 50 MIL)



10 - 171,9 MOA | 2,9 - 50 MIL

Aufpreis Cerakote Beschichtung / Surcharge Cerakote coating (armor black, coyote tan, flat dark, tactical grey)

€ 21,40

## TAKTISCHE PICATINNY BLOCKMONTAGEN TACTICAL PICATINNY BLOCKMOUNTS

Qualitativ hochwertige Aluminium Blockmontagen aus dem Vollen gefräst.  
High quality aluminium blockmounts milled from solid.



**1** Blockmontagen für Picatinny- / Weaver-Schienen  
Blockmounts for Picatinny- / Weaver-rails  
(Achshöhe / axis height: 36 mm / 42 mm)

**2** Taktische Blockmontagen für Picatinny- / Weaver-Schienen  
Tactical Blockmounts for Picatinny- / Weaver-rails  
(Achshöhe / axis height: 36 mm / 42 mm)

€ 310,20 Blockmontagen (Achshöhe: 42 mm)   Blockmounts (axis height: 42 mm)			
Ø 30 mm	0 MOA		Art.Nr.: WZZFWE-11-(B001/B014)
Ø 30 mm	20 MOA		Art.Nr.: WZZFWE-11-(B002/B015)
Ø 30 mm	35 MOA		Art.Nr.: WZZFWE-11-(B005/B016)
Ø 34 mm	0 MOA		Art.Nr.: WZZFWE-11-(B010/B017)
Ø 34 mm	20 MOA inkl. Libelle / incl. lever		Art.Nr.: WZZFWE-11-(B011/B018)
Ø 34 mm	35 MOA		Art.Nr.: WZZFWE-11-(B013/B019)
Ø 36 mm	50 MOA		Art.Nr.: WZZFWE-11-(B023/B024)

€ 330,20 Blockmontagen (Achshöhe: 36 mm)   Blockmounts (axis height: 36 mm)			
Ø 34 mm	0 MOA inkl. Libelle / incl. lever		Art.Nr.: WZZFWE-11-(B025/B030)
Ø 34 mm	20 MOA inkl. Libelle / incl. lever		Art.Nr.: WZZFWE-11-(B026/B031)
Ø 34 mm	35 MOA inkl. Libelle / incl. lever		Art.Nr.: WZZFWE-11-(B027/B032)

Aufpreis Cerakote Beschichtung (armor black, flat dark earth, coyote tan, tactical grey)  
Surcharge Cerakote coating (armor black, flat dark earth, coyote tan, tactical grey)

€ 64,20

## VOERE SCHUSSWINKELKOMPENSATOR VOERE ANGLE COSINE INDICATOR

Schusswinkelkompensator mit Universalanbindung + Halter für Picatinny- / Weaver-Schienen

Der Schusswinkelkompensator ist ein Must-have beim Schießen auf große Distanzen. Bei Zielen auf große Distanzen kommt es zu Abweichungen der Geschossflugbahn. Der Schusswinkelkompensator ermöglicht diese veränderte Treffpunktlage (Flugbahnkompensation) zu berechnen.

Der **VOERE Schusswinkelkompensator** kann auf unsere taktischen Blockmontagen, wie auch auf allen Picatinny- und Weaver-Schienen angebracht werden.

- Beidseitig verwendbar.
- Halter für Picatinny- / Weaver-Schienen
- Hilft dem Schützen Verkantungsfehler zu vermeiden.
- Skalierung in Winkelgraden
- Für Montagen Ø30 mm / Ø34 mm / Ø36 mm geeignet.

Angle cosine indicator with universal device + device for Picatinny- / Weaver-rails

The angle cosine indicator is a must-have when shooting at long distances. When shooting at long distances, the bullet trajectory is subject to deviations. The angle cosine indicator makes it possible to calculate this changed point of impact (trajectory compensation).

The **VOERE Angle Cosine Indicator** can be mounted on our Tactical blockmount as well as on all Picatinny- and Weaver-rails.

- Can be used on both sides.
- Device for Picatinny- / Weaver-rails
- Lever helps shooter to avoid canting errors.
- Scaling in angular degrees
- Suitable for mounts Ø30 mm / Ø34 mm / Ø36 mm.



**VOERE Schusswinkelkompensator + Halter**  
VOERE Angle Cosine Indicator + device  
(Art.Nr.: WZZFWE-11-A051)

**VOERE Schusswinkelkompensator**  
VOERE Angle Cosine Indicator  
(Art.Nr.: WZZFWE-11-B006)

**Libelle für Picatinny- / Weaver-Schienen**  
Lever for Picatinny- / Weaver-rails  
(Art.Nr.: WZZFWE-11-B008)

## VOERE SCHNELLWECHSELMONTAGEN

### VOERE QUICK-DETACHABLE MOUNTS

Unsere VOERE Schnellwechsellmontagen sind für unsere Modelle LBW, 2155, 2165, Tirolerin und S16 verfügbar. Diese Montagen zeichnen sich durch eine einfache Handhabung und Einwechselbarkeit ohne Präzisionsverlust aus.

Die patentierte VOERE-Schnellwechsellmontage besteht aus der Basisplatte auf der Waffe und dem schnellabnehmbaren Montage-Oberteil für das Zielfernrohr.

*Our VOERE Quick-Detachable mounts are available for our models LBW, 2155, 2165 Tirolerin and S16. These mounts are characterized by easy handling, robustness and interchangeability without loss of precision.*

*The VOERE Quick-Detachable mount consists of the base plate mounted on the rifle and the quick-detachable mounting top for the scope.*

## MONTAGE-BASEN FÜR SCHNELLWECHSELMONTAGEN

### MOUNTING BASES FOR QUICK-DETACHABLE MOUNTS



**Basenplatte für org. K98**  
Base plate for org. M98  
(ZB0065)



€ 68,-  
(Art.Nr.: WZZFQD-11-B065)

**Basenplatten für K98 St.Barbara**  
Base plates for M98 St.Barbara  
(ZB0066)



€ 68,-  
(Art.Nr.: WZZFQD-11-B066)

**Basenplatten für Mod. LBW/S16**  
Base plates for Mod. LBW/S16  
(ZB2003)



€ 68,-  
Art.Nr.: WZZFQD-11-(B003/B004)

**Basenplatten für Mod. Tirolerin**  
Base plates for Mod. Tirolerin  
(ZB2006)



€ 68,-  
(Art.Nr.: WA2006-11-A001)

**Basenplatte für Mod. 2185**  
Base plate for Mod. 2185  
(ZB0085)



€ 68,-  
(Art.Nr.: WZZFQD-11-B085)

## MONTAGE-BASEN FÜR MODELLE ANDERER HERSTELLER

### MOUNTING BASES FOR MODELS OF OTHER MANUFACTURERS

**Basenplatte für Sauer® 202 Magnum**  
Base plate for Sauer® 202 Magnum  
(ZB0014)



€ 68,-  
(Art.Nr.: WZZFQD-11-B014)

**Basenplatte für Sauer® 202 ST**  
Base plate for Sauer® 202 ST  
(ZB0015)



€ 68,-  
(Art.Nr.: WZZFQD-11-B015)

**Basenplatte für Sauer® 200 MG**  
Base plate for Sauer® 200 MG  
(ZB0016)



€ 68,-  
(Art.Nr.: WZZFQD-11-B016)

**Basenplatte für Remington® 700**  
Base plate for Remington® 700  
SHORT ACTION (ZB0023)



€ 68,-  
(Art.Nr.: WZZFQD-11-B023)

**Basenplatte für Remington® 700**  
Base plate for Remington® 700  
LONG ACTION (ZB0024)



€ 68,-  
(Art.Nr.: WZZFQD-11-B024)

**Basenplatte für Steyr Mannlicher®**  
Base plate for Steyr Mannlicher®  
Jagdmatch SL/L (ZB0025)



€ 68,-  
(Art.Nr.: WZZFQD-11-B025)

**Basenplatte für Steyr Mannlicher®**  
Base plate for Steyr Mannlicher®  
LUXUS M/S (ZB0027)



€ 68,-  
(Art.Nr.: WZZFQD-11-B027)

**Basenplatte für Remington® 7600**  
Base plate for Remington® 7600  
(ZB0028)



€ 68,-  
(Art.Nr.: WZZFQD-11-B028)

**Basenplatte zur Selbstanpassung**  
Base plate for self-adjustment  
(ZB0098)



€ 68,-  
(Art.Nr.: WZZFQD-11-B098)

## MONTAGE-OBERTEILE FÜR SCHNELLWECHSELMONTAGEN TOP-MOUNTS FOR QUICK-DETACHABLE MOUNTS

**Montage-Schiene (Basis)**  
*Mounting-rail (base)*  
(ZO1000)



**€ 213,90**

(Art.Nr.: WZZFQD-11-A001)

**Schiene für Diopter - 11 mm Prisma**  
*Rail for diopter - 11 mm prism*  
(ZO1011)



**€ 254,70**

(Art.Nr.: WZZFQD-11-A011)

**Universal-Adapter verlängert**  
*Universal-adapter extended*  
(ZO1012)



**€ 278,50**

(Art.Nr.: WZZFQD-11-A012)

**Swarovski / Zeiss Prisma**  
*Swarovski / Zeiss prism*  
(ZO1040)



**€ 254,70**

(Art.Nr.: WZZFQD-11-A040)

**Zeiss Diatal / Diavari**  
*Zeiss Diatal / Diavari*  
(ZO1050)



**€ 278,50**

(Art.Nr.: WZZFQD-11-A050)

**Swarovski-Optik Zahnschiene**  
*Swarovski-Optic rack rail*  
(ZO1060)



**€ 278,50**

(Art.Nr.: WZZFQD-11-A060)

**Schmidt & Bender Schiene**  
*Schmidt & Bender rail*  
(ZO1070)



**€ 278,50**

(Art.Nr.: WZZFQD-11-A070)

**Weaver-Schiene**  
*Weaver-rail*  
(ZO1080)



**€ 278,50**

(Art.Nr.: WZZFQD-11-A080)

**Weaver-Schiene (ohne Montage-Schiene)**  
*Weaver-rail (without mounting-rail)*  
(ZO1080)



**€ 77,50**

(Art.Nr.: WZZFQD-11-B080)

## MONTAGE-OBERTEILE FÜR SCHNELLWECHSELMONTAGEN MIT RINGEN TOP-MOUNTS FOR QUICK-DETACHABLE MOUNTS WITH RINGS

**1 | Montage-Oberteil mit Ringen**  
*Top-mount with rings*

Ø 26 mm (ZO1026)

**€ 254,70**

(Art.Nr.: WZZFQD-11-A026)

Ø 30 mm (ZO1030)

**€ 278,50**

Art.Nr.: WZZFQD-11-(A030/A032)

Ø 34 mm (ZO1034)

**€ 289,10**

(Art.Nr.: WZZFQD-11-A090)

**2 | Montage-Oberteil mit Ringen gekröpft**  
*Top-mount with rings swan-necked*

Ø 26 mm (ZO1027)

**€ 265,50**

(Art.Nr.: WZZFQD-11-A027)

Ø 30 mm (ZO1031)

**€ 289,10**

(Art.Nr.: WZZFQD-11-A031)



## MONTAGE-RINGE FÜR JAGDMODELLE MOUNTING-RINGS FOR HUNTING MODELS

**Montage-Ringe für Picatinny- und Weaver-Schienen für leichte und mittlere Kaliber (2-teilig)**  
*Mounting rings for Picatinny- and Weaver-rails for light and medium calibres (2-parts)*

**1 | Montage-Ringe (Ø 25,4 mm)**  
*Mounting-rings (Ø 1")*

Bauhöhe: 22 mm | Height: 22 mm

**€ 64,20**

(Art.Nr.: WZZFWE-11-A002)

**2 | Montage-Ringe (Ø 30 mm)**  
*Mounting-rings (Ø 30 mm)*

Bauhöhe: 22 mm | Height: 22 mm

**€ 74,90**

(Art.Nr.: WZZFWE-11-A001)



## PICATINNY- UND WEAVER-SCHIENEN FÜR JAGDMODELLE

### PICATINNY- AND WEAVER-RAILS FOR HUNTING MODELS

Hochwertige Picatinny- und Weaver-Schienen für K98 und VOERE Modelle  
*High-quality Picatinny- and Weaver-rails for M98 and VOERE Models*

#### Weaver-Basen für Mod. LBW/S16 Weaver-bases for Mod. LBW/S16

Bauhöhe: 7 mm / 10 mm | Height: 7 mm / 10 mm



€ 53,50

Art.Nr.: WA2003-11-(A001/A002) (ZB0033)

#### Aluminium Picatinny-Schiene für Mod. LBW/S16 Aluminium Picatinny-rail for Mod. LBW/S16

0 MOA | Bauhöhe: 8 mm | Height: 8 mm

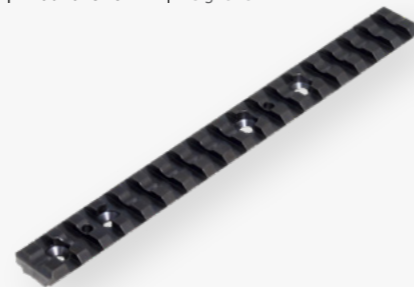

€ 79,90

Art.Nr.: WZZFWE-11-A038

#### Weaver-Basen für K98 St.Barbara Weaver-bases for M98 St.Barbara

Bauhöhe: 5 mm / 9 mm | Height: 5 mm / 9 mm



€ 53,50

Art.Nr.: WZZFWE-11-0007 (ZB0067)

#### Stahl Picatinny-Schiene für org. K98 / St.Barbara Steel Picatinny-rail for org. M98 / St.Barbara

Bauhöhe: 8 mm | Height: 8 mm



€ 106,90

Art.Nr.: WZZFWE-11-0008 (ZB0069)

#### Weaver-Basen für Mod. Tirolerin Weaver-bases for Mod. Tirolerin

Bauhöhe: 9 mm | Height: 9 mm



€ 53,50

Art.Nr.: WA2006-11-A002 (ZB0011)

#### Stahl Picatinny-Schiene für Mod. Tirolerin Steel Picatinny-rail for Mod. Tirolerin

Bauhöhe: 6 mm | Height: 6 mm



€ 106,90

Art.Nr.: WA2006-11-A003

## KLEINKALIBER-MONTAGEN | RIMFIRE SCOPE MOUNTS

Zielfernrohr-Montagen geeignet für Luftdruck- als auch Kleinkalibergewehre mit 11 mm Prisma-Schiene.  
*Scope mounts suitable for air rifles as well as Rimfire-rifles with 11 mm prism rail.*



Picatinny-Schiene geeignet für  
 Schusswinkelkompensatoren / Libellen  
*Picatinny-rail suitable for Angle Cosine  
 Indicators / levers*

Geeignet für jedes Kleinkalibergewehr mit 11mm  
 Prisma-Schiene durch passende Ausfräsung.  
*Suitable for every Rimfire Bolt-Action rifle with  
 11 mm Prism-rail due to matching cut out.*

Libelle | lever

#### Taktische Blockmontagen (11mm) | Tactical Blockmounts (11mm)

Ø 25,4 mm / 1"	0 MOA   28 mm	€ 192,50	Art.Nr.: WZZFWE-11-B028
Ø 30 mm	0 MOA   30 mm	€ 192,50	Art.Nr.: WZZFWE-11-B029

#### 1 | Montage-Ringe (Ø 30 mm)

Mounting-rings (Ø 30 mm)

Bauhöhe: 36 mm | Height: 36 mm

€ 53,50 | WA2015-11-A006



#### 2 | Blockmontage (Ø 30 mm)

Blockmount (Ø 30 mm)

Bauhöhe: 36 mm | Height: 36 mm

€ 64,20 | WA2015-11-A007



## VOERE X ZWEIBEIN MIT UNIVERSALAUFNAHME

VOERE X BIPOD WITH UNIVERSAL DEVICE

### 3 in 1 ZWEIBEIN

Universalaufnahme geeignet für:

- Parker Hale / VersaPod / Fortmeier
- Picatinny- / Weaver-Schiene
- 12 Uhr Montage-Schiene

- Für Kaliber 222 Rem. - 50 Browning
- 90° klappbar
- In 12 Stufen in der Länge durch Schnellverstellung justierbar
- Ideal für Longrange, Jagd, kurze und lange Distanzen
- Kombinationszweibein aus Aluminium und Karbon
- für extreme Stabilität und Belastbarkeit

### 3 in 1 BIPOD

Universal device suitable for:

- Parker Hale / VersaPod / Fortmeier
- Picatinny- / Weaver-rail
- 12 o'clock assembling

- For calibres 222 Rem. - 50 Browning
- 90° foldable
- Length adjustable in 4 or 12 steps by quick adjustment
- Ideal for long range, hunting, short and long distances
- Aluminum and carbon combination-bipod for extreme stability and durability



Zweibein Verlängerung  
Bipod extension

€ 62,- | Art.Nr.: WZ2BEIN-05-B004



Gummifuß Verlängerung  
Rubber foot extension

€ 62,- | Art.Nr.: WZ2BEIN-05-B004



Edelstahlfüße  
Stainless steel feet

€ 42,80 | Art.Nr.: WZ2BEIN-05-B003

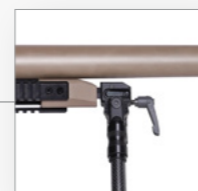

- Parker Hale  
- VersaPod  
- Fortmeier



- Picatinny-Schiene  
- Picatinny-rail

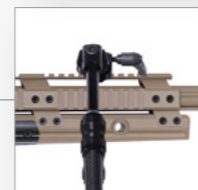

- 12 Uhr Montage  
- 12 o'clock assemble

€ 320,80

(Art.Nr.: WZBEIN-05-A002)

## ADAPTER FÜR ZWEIBEINE | ADAPTER FOR BIPODS

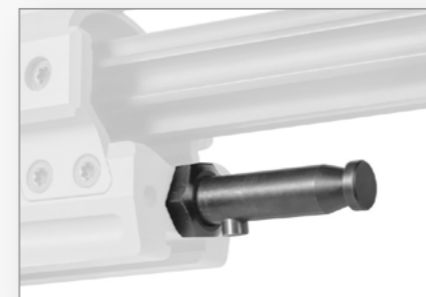

**1 | Zweibein-Adapter (VOERE X-Serie)**  
**Bipod-Adapter (VOERE X-Series)**  
(Parker Hale / VersaPod / Fortmeier)  
€ 53,50 | Art.Nr.: WA2009-05-A010



**2 | Picatinny-Adapter für UIT-Schiene**  
**Picatinny-Adapter for UIT-rail**  
€ 179,60 | Art.Nr.: WZZFWE-11-A050



**3 | Weaver-Schiene / Weaver-rail**  
(Parker Hale / VersaPod / Fortmeier)  
€ 42,80 | Art.Nr.: WA2015-05-A005

## VOERE ERDSPORN - MINI | VOERE MONOPOD - MINI

- Schnellverstellung
- Feinjustierung
- universelle Picatinny- / Weveraufnahme
- Farbe: schwarz
- Material: Kombination aus Aluminium und Stahl

- Quick adjustment
- Fine adjustment
- Universal Picatinny- and Weaver-connection
- Colour: black
- Material: Combination of aluminium and steel



Feinjustierung / fine adjustment



klappbar 90° / foldable 90°

€ 199,90

(Art.Nr.: WA2003-12-A001)

## K98 ABZÜGE | M98 TRIGGERS

Passend für K98-Gewehre und VOERE Modelle. / Suitable for K98-rifles and VOERE Models.

### Org. Druckpunktanzug (F) Org. Two-stage trigger (F)



Einstellbar: Abzugsgewicht  
Adjustable: trigger weight

€ 21,40 | Art.Nr.: WA2155-04-(A001/A006)

### Deutscher Stecher (ST) Double-stage trigger (ST)



Einstellbar: Rastüberschneidung, Vorspanngewicht  
Adjustable: detent overlap, preload weight

€ 115,50 | Art.Nr.: WA2155-04-A004

### Rückstecher (RST) Single-set trigger (RST)



Einstellbar: Rastüberschneidung  
Adjustable: detent overlap

€ 149,70 | Art.Nr.: WA2003-04-A003

### Matchdruckpunktanzug (MD) Two-stage Match trigger (MD)



Einstellbar: Abzugsgewicht, Vorweg, Druckpunkt  
Adjustable: weight, first stage travel: pressure point

€ 181,90 | Art.Nr.: WA2003-04-A005

### Matchdruckpunktanzug (MD) Two-stage Match trigger (MD)



Einstellbar: Abzugsgewicht, Vorweg, Druckpunkt  
Adjustable: weight, first stage travel: pressure point

€ 181,90 | Art.Nr.: WA2003-04-A007

### Matchdruckpunktanzug (MD) Two-stage Match trigger (MD)



Einstellbar: Abzugsgewicht, Vorweg, Druckpunkt  
Adjustable: weight, first stage travel: pressure point

€ 181,90 | Art.Nr.: WA2003-04-A008

### Direktanzug (MD) Direct trigger (MD)



Einstellbar: Abzugsgewicht, Rastüberschneidung  
Adjustable: weight, detent overlap

€ 149,70 | Art.Nr.: WA2003-04-A001

### Umrüstsatz für Mod. 2165 auf Direktanzug / Rückstecher / Matchdruckpunktanzug Conversion kit Mod. 2165 to Direct trigger / Single set trigger / Two-stage Match trigger



ohne Kammer Sperre, Schiebepfandung  
Umrüstsatz inkl. Sicherheitsschieber exkl. Abzug

without bolt lock, top-tang safety  
Conversion kit incl. safety slide excl. trigger

€ 171,10 | Art.Nr.: WA2165-04-A003

## VOERE, FREMDPRODUKTE | VOERE, THIRD-PARTY PRODUCTS

### Matchdruckpunktanzug (MD) Two-stage Match trigger (MD)



Finger-Stop

(Remington® 700)

Einstellbar: Abzugsgewicht, Vorweg, Druckpunkt  
Adjustable: weight, first stage travel: pressure point

€ 171,30 | Art.Nr.: WZR700-04-A001

### Matchdruckpunktanzug (MD) Two-stage Match trigger (MD)



Finger-Stop

(Remington® 700)

Einstellbar: Abzugsgewicht, Vorweg, Druckpunkt  
Adjustable: weight, first stage travel: pressure point

€ 171,30 | Art.Nr.: WZR700-04-A001

### Matchdruckpunktanzug (MD) Two-stage Match trigger (MD)



Finger-Stop

(Remington® 700)

Einstellbar: Abzugsgewicht, Vorweg, Druckpunkt  
Adjustable: weight, first stage travel: pressure point

€ 171,30 | Art.Nr.: WZR700-04-A001

### Rückstecher (RST) Single-set trigger (RST)



(Mod. LBW Standard)

Einstellbar: Rastüberschneidung  
Adjustable: detent overlap

€ 160,50 | Art.Nr.: WA2003-04-A004

### Direktanzug (MF) Direct trigger (MF)



(Mod. LBW Standard)

Einstellbar: Abzugsgewicht, Vorweg, Druckpunkt  
Adjustable: weight, first stage travel: pressure point

€ 160,50 | Art.Nr.: WA2003-04-A002

### Kombianzug Combination trigger



(Mod. LBW Tirolerin)

Einstellbar: Rastüberschneidung  
Adjustable: detent overlap

€ 113,40 | Art.Nr.: WA2006-04-A001

### Matchdruckpunktanzug (MD) Two-stage Match trigger (MD)



Finger-Stop

(Mod. S16 / K15A)

Einstellbar: Abzugsgewicht, Vorweg, Druckpunkt  
Adjustable: weight, first stage travel: pressure point

€ 99,80 | Art.Nr.: WA2016-04-A001

### Matchdruckpunktanzug (MD) Two-stage Match trigger (MD)



(Mod. S16 / K15A)

Einstellbar: Abzugsgewicht, Vorweg, Druckpunkt  
Adjustable: weight, first stage travel: pressure point

€ 119,80 | Art.Nr.: WA2016-04-A003

### Abzugszügel | Trigger blade (Mod. CZ® 452)



€ 110,60 | Art.Nr.: WZCCK-04-B001

## MAGAZINE | MAGAZINES

Wir fertigen Magazine für unsere eigenen Produkte als auch für Fremdprodukte, sowie nach Kundenwunsch in höheren Stückzahlen.

Durch einen 3D-Metalldruck ist es uns möglich verschiedenste Kapazitäten und Größen zu produzieren.

*We produce rifle magazines for our own and third-party products according to our customer requirements in low- and high quantities.*

*3D-metal printing enables us to produce a wide variety of capacities and sizes.*



**1 | Stahlmagazin für Mod. LBW/M2**  
3-Schuss - Standard (ST) | 2-Schuss - Magnum (MG)  
Kaliber: 222 Rem. - 338 Lapua Mag.

**1 | Steel magazine for Mod. LBW/M2**  
3-rounds - Standard (ST) | 2-rounds - Magnum (MG)  
Calibre: 222 Rem. - 338 Lapua Mag.

€ 106,90

Art.Nr.: WA2003-06-(A001-A017)



**2 | Stahlmagazin für Mod. LBW/M2**  
5-Schuss - Standard (ST) | 4-Schuss - Magnum (MG)  
Kaliber: 222 Rem. - 338 Lapua Mag.

**2 | Steel magazine for Mod. LBW/M2**  
5-rounds - Standard (ST) | 4-rounds - Magnum (MG)  
Calibre: 222 Rem. - 338 Lapua Mag.

€ 128,30

Art.Nr.: WA2003-06-(A021-A036)



**3 | Stahlmagazin für Mod. LBW/M2**  
10-Schuss - Standard (ST)  
Kaliber: 6,5x55 SE / 6,5 Creedmoor / 308 Win.

**3 | Steel magazine for Mod. LBW/M2**  
10-rounds - Standard (ST)  
Calibre: 6,5x55 SE / 6,5 Creedmoor / 308 Win.

€ 320,80

Art.Nr.: WA2003-06-A040

*Magazin Adapter für Kaliber 375 H&H und 338 Lapua Mag. notwendig.  
Magazine adapter for calibre 375 H&H and 338 Lapua Mag. necessary.*



**4 | Stahlmagazin für Mod. Tirolerin**  
3-Schuss - Standard (ST) | 2-reihiges Magazin  
Kaliber: 6,5x55 SE - 9,3x62

**4 | Steel magazine for Mod. Tirolerin**  
3-rounds - Standard (ST) | 2-row magazine  
Calibre: 6,5x55 SE - 9,3x62

€ 106,90

Art.Nr.: WA2006-06-A001



**5 | 5-Schuss Polymermagazin für Mod. S16**  
Kaliber: 17 Rem., 222 Rem., 223 Rem., 300 AAC BLK

**5 | 5-rounds Polymer magazine for Mod. S16**  
Calibre: 17 Rem., 222 Rem., 223 Rem., 300 AAC BLK

€ 25,70

Art.Nr.: WA2016-06-A002



**6 | 5-Schuss Polymermagazin für Mod. K15A, Tirolerin, V3** | Kaliber: .22 lr.

**6 | 5-rounds Polymer magazine for Mod. K15A, Tirolerin, V3** | Calibre: .22 lr.

€ 25,70

Art.Nr.: WA2015-06-A001



**7 | 8-Schuss Stahlmagazin für KK-Halbautomaten**  
Kaliber: .22 lr. | Mod.: 2114 / 2115 / 2117 / 1014 / 0014

**7 | 8-rounds steel magazine for Semi-automatic rimfire-rifles** € 47,10  
Calibre: .22 lr. | Mod.: 2114 / 2115 / 2117 / 1014 / 0014

Art.Nr.: WA2114-06-A001

**8 | 8-Schuss Stahlmagazin für KK-Repetierer (VOERE Vöhrenbach)**  
Kaliber: .22 lr. | Mod.: 1007 / 2107 / 2108 / 2112

**8 | 8-rounds steel magazine for Rimfire Bolt action rifles** € 51,50  
Calibre: .22 lr. | Mod.: 1007 / 2107 / 2108 / 2112

Art.Nr.: WA2114-06-A002



### 9 | 2-Schuss Stahlmagazin für Mod. 2185

Auch passend für Sauer® STR 200 / 202, Unique Alpine® TPG 1.  
Kaliber / calibre: 7x64 / 7mm Rem. Mag. / 9,3x62 / 308 Win.  
30-06 Spring. / 300 Win. Mag.

9 | 2-rounds Steel magazine for Mod. 2185

ab / from **€ 106,90**  
Art.Nr.: WA2185-06-(A001-A005)



### 13 | 5/6-Schuss Stahlmagazin für Mod. X3/X4

Kaliber: 300 Win. Mag. / 300 Norma Mag. / 338 Lapua Mag.  
375 SWISS P / 375 CT / 408 CT

13 | 5/6-rounds Steel magazine for Mod. X3/X4

Calibre: 300 Win. Mag. / 300 Norma Mag. / 338 Lapua Mag.  
375 SWISS P / 375 CT / 408 CT

**€ 235,30**

Art.Nr.: WA2012-06-(A001-A009)



### 10 | 5-Schuss Stahlmagazin für Mod. 2185

Auch passend für Sauer® STR 200 / 202, Unique Alpine® TPG 1.  
Kaliber / calibre: 7x64 / 9,3x62 / 308 Win. / 30-06 Spring. / 300 Win. Mag.

10 | 5-rounds Steel magazine for Mod. 2185

ab / from **€ 128,30**  
(Art.Nr.: WA2185-06-A011-A014)



### 14 | 5/10-Schuss Polymermagazine für Mod. X3/X4

Kaliber: 6,5x47 Lapua / 308 Win.  
300 Norma Mag. / 338 Lapua Mag.

14 | 5/10-rounds Polymer magazines for Mod. X3/X4

Calibre: 6,5x47 Lapua / 308 Win.  
300 Norma Mag. / 338 Lapua Mag.

**€ 160,50**

Art.Nr.: WA2012-06-(A010/A016)



### 11 | Stahlmagazin für K98 Umrüstsatz | Mod. 2155/2165

3-Schuss - Standard (ST) | 2-Schuss - Magnum (MG)  
Kaliber: 6,5x55 SE - 338 Win. Mag.

11 | Steel magazine for conversion kit M98 | Mod. 2155/2165

3-rounds - Standard (ST) | 2-rounds - Magnum (MG)  
Calibre: 6,5x55 SE - 338 Win. Mag.

**€ 106,90**

Art.Nr.: WA2155-06-(A001-A005)



### 15 | Edelstahlmagazin für Mod. X3/X4

Metalldruck / Kaliber und Kapazität auf Anfrage

15 | Stainless steel magazine for Mod. X3/X4

Metal print / Calibre and capacity on request

**€ 534,70**

Art.Nr.: WA2012-06-A0..



### 12 | Stahlmagazin für K98 Umrüstsatz | Mod. 2155/2165

5-Schuss - Standard (ST) | 4-Schuss - Magnum (MG)  
Kaliber: 6,5x55 SE - 338 Win. Mag.

12 | Steel magazine for conversion kit M98 | Mod. 2155/2165

5-rounds - Standard (ST) | 4-rounds - Magnum (MG)  
Calibre: 6,5x55 SE - 338 Win. Mag.

**€ 128,30**

Art.Nr.: WA2155-06-(A011-A016)



### 16 | 4-Schuss Stahlmagazin für Mod. X5

Kaliber: 416 TYR / 416 Barrett / 460 Steyr  
50 Browning / 12,7x108

16 | 4-rounds Steel magazine for Mod.

Calibre: 416 TYR / 416 Barrett / 460 Steyr  
50 Browning / 12,7x108

**€ 320,80**

Art.Nr.: WA2013-06-(A001-A003)

## WECHSELLÄUFE | BARRELS

Unsere Läufe werden von Qualitätsherstellern bezogen, werden bei uns im Haus selber produziert und gefertigt. Viele unserer Waffen besitzen ein Laufwechselsystem, wo der Lauf mit wenigen Handgriffen entfernt und durch einen anderen getauscht werden kann.

*Our barrels are sourced from quality manufacturers, or are produced and manufactured in-house. Many of our weapons have a barrel change system, where the barrel can be removed in a few easy steps and another barrel can be substituted easily.*

## JAGDLÄUFE | HUNTING BARRELS



### Jagd Stahllauf (Mod. LBW/M2) | Hunting Steel barrel (Mod. LBW/M2)

- Mündungsdurchmesser: Ø15/16 mm
- Lauflänge: 60 cm / 65 cm
- Kaliber: siehe Mod. LBW
- Muzzle diameter: Ø15/16 mm
- Barrel length: 60 cm / 65 cm
- Calibre: see Mod. LBW

€ 705,80

Art.Nr.: WA2003-01-A0..



### Jagd Stahl-Karbonlauf (Mod. LBW/M2) | Hunting Steel-Carbon barrel (Mod. LBW/M2)

- Mündungsdurchmesser: Ø17 mm
- Lauflänge: 60 cm
- Gewinde am Lauf: M13,5x1
- Kaliber / Calibre: 222 Rem. / 223 Rem. / 6,5x55 SE / 7x64 / 7mm Rem. Mag. / 8x57 IS / 9,3x62 / 270 Win. / 308 Win. / 30-06 Spring.
- Muzzle diameter: Ø17 mm
- Barrel length: 60 cm
- Barrel thread: M13,5x1

€ 898,20

Art.Nr.: WA2003-01-A0..



### Jagd Stahllauf (Mod. Tirolerin / VICTOR 3) | Hunting Steel barrel (Mod. Tirolerin/VICTOR 3)

- Mündungsdurchmesser: Ø15 mm
- Lauflänge: 55 cm
- Gewinde am Lauf: M14x1
- Kaliber: siehe Mod. Tirolerin
- Muzzle diameter: Ø15 mm
- Barrel length: 55 cm
- Barrel thread: M14x1
- Calibre: see Mod. Tirolerin

€ 855,50

Art.Nr.: WA2006-01-A0..

## VARMINTLÄUFE | VARMINT BARRELS



### Varmint Stahllauf (Mod. LBW/M2) | Varmint Steel barrel (Mod. LBW/M2)

- Mündungsdurchmesser: Ø21 mm
- Lauflänge: 66 cm
- Kaliber / Calibre: 6,5x47 Lapua / 6,5 Creedmoor / 6,5x55 SE / 7mm-08 Rem. / 22-250 Rem. / 25-06 Rem. / 243 Win. / 308 Win.
- Diameter: Ø21 mm
- Barrel length: 66 cm

€ 919,60

Art.Nr.: WA2003-01-A0..



### Varmint Stahl-Karbonlauf (Mod. LBW/M2) | Varmint Steel-Carbon barrel (Mod. LBW/M2)

- Mündungsdurchmesser: Ø23 mm
- Lauflänge: 65 cm
- Gewinde am Lauf: M14x1
- Kaliber / Calibre: 6,5x55 SE / 7x64 / 7mm Rem. Mag. / 22-250 Rem. / 270 Win. / 30-06 Spring. / 300 Win. Mag.
- Diameter: Ø23 mm
- Barrel length: 65 cm
- Barrel thread: M14x1

€ 1.176,30

Art.Nr.: WA2003-01-A0..



### Varmint Stahläufe (Mod. LBW/M2) | Varmint Steel barrels (Mod. LBW/M2)

- Mündungsdurchmesser: Ø21 mm
- Lauflänge: 51 cm / 60 cm
- Gewinde am Lauf: M18x1
- Kaliber / Calibre: 6,5 Creedmoor / 308 Win.
- Diameter: Ø21 mm
- Barrel length: 51 cm / 60 cm
- Barrel thread: M18x1

€ 919,60

Art.Nr.: WA2003-01-A0..



**Varmint Stahl-Karbonlauf (Mod. VICTOR 3) | Varmint Steel-Carbon barrel (Mod. VICTOR 3)**

- Mündungsdurchmesser: Ø23 mm
- Lauflänge: 55 cm
- Kaliber / Calibre: 243 Win. / 308 Win.
- Diameter: Ø23 mm
- Barrel length: 55 cm

€ 919,60

Art.Nr.: WA2021-01-A001

## JAGDLÄUFE MIT INTEGRAL OVER-BARREL SCHALLDÄMPFER HUNTING BARRELS WITH INTEGRAL OVER-BARREL SUPPRESSOR



**Jagd Stahllauf mit Over-Barrel Schalldämpfer (Mod. LBW/M2)  
Steel Hunting barrel with Over-Barrel Suppressor (Mod. LBW/M2)**

- Lauflänge: 39 cm
- Länge inkl. Schalldämpfer: 55 cm
- Kaliber / Calibre: 308 Win.
- Barrel length: 39 cm
- Length incl. Suppressor: 55 cm

€ 1.176,30

Art.Nr.: WA2003-01-A109



**Jagd Stahllauf mit Over-Barrel Schalldämpfer (Mod. LBW/M2)  
Steel Hunting barrel with Over-Barrel Suppressor (Mod. LBW/M2)**

- Lauflänge: 39 cm
- Länge inkl. Schalldämpfer: 55 cm
- Kaliber / Calibre: 308 Win.
- Barrel length: 39 cm
- Length incl. Suppressor: 55 cm

€ 1.176,30

Art.Nr.: WA2021-01-A003

## MATCHLÄUFE | MATCH BARRELS

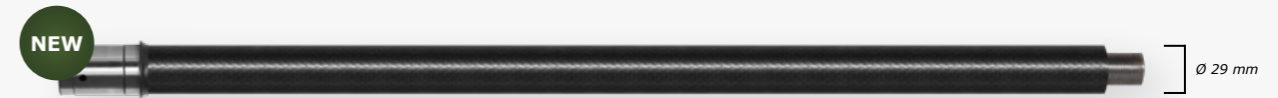

**Match Stahllauf, gehämmert (Mod. VICTOR 3) | Match Steel barrel, hammer forged (Mod. VICTOR 3)**

- Mündungsdurchmesser: Ø29 mm
- Lauflänge: 60 cm
- Gewinde am Lauf: M19x1
- Kaliber / Calibre: 6,5 Creedmoor / 308 Win.
- Muzzle diameter: Ø29 mm
- Barrel length: 60 cm
- Barrel thread: M19x1

€ 919,60

Art.Nr.: WA2021-01-A002



**Match Stahllauf, gehämmert (Mod. ALPHA 3) | Match Steel barrel, hammer forged (Mod. ALPHA 3)**

- Mündungsdurchmesser: Ø29 mm
- Lauflänge: 52 cm
- Gewinde am Lauf: M19x1
- Kaliber / Calibre: 223 Rem. / 308 Win.
- Muzzle diameter: Ø29 mm
- Barrel length: 52 cm
- Barrel thread: M19x1

€ 919,60

Art.Nr.: WA2021-01-A002



**Matchlauf Edelstahl, geflutet (Mod. LBW/M2) | Match Stainless-steel barrel, fluted (Mod. LBW/M2)**

- Mündungsdurchmesser: Ø23 mm
- Lauflänge: 51 cm / 66 cm / 69 cm
- Gewinde am Lauf: M19x1
- Kaliber / Calibre: 223 Rem. / 6,5x47 Lapua / 6,5 Creedmoor / 6,5x55 SE  
308 Win. / 300 Win. Mag. / 300 Norma Mag. / 338 Lapua Mag.
- Muzzle diameter: Ø23 mm
- Barrel length: 51 cm / 66 cm / 69 cm
- Barrel thread: M19x1

€ 1.176,30

Art.Nr.: WA2003-01-A0..

Matchläufe werden standardmäßig ohne Mündungsbremse und ohne Beschichtung geliefert.  
Match barrels as standard without muzzle brakes and without coating.

## BARRELED ACTIONS



### Matchlauf Edelstahl, geflutet (Mod. X3) | Match Stainless-steel barrel, fluted (Mod. X3)

- Mündungsdurchmesser: Ø23 mm
- Lauflänge: 66 cm / 69 cm / 72 cm
- Gewinde am Lauf: M19x1
- Kaliber / Calibre: 6,5x47 Lapua / 6,5 Creedmoor / 308 Win. / 300 Win. Mag. / 300 Norma Mag. / 338 Lapua Mag. / 375 CT / 408 CT

€ 1.497,-

Art.Nr.: WA2012-01-A0..



### Matchlauf Edelstahl, geflutet (Mod. X4) | Match Stainless-steel barrel, fluted (Mod. X4)

- Mündungsdurchmesser: Ø23 mm
- Lauflänge: 69 cm / 72 cm
- Gewinde am Lauf: M19x1
- Kaliber / Calibre: 300 Norma Mag. / 338 Lapua Mag. / 375 CT / 408 CT

€ 1.604,-

Art.Nr.: WA2013-01-(A002-A005)



### Matchlauf Edelstahl, ungeflutet (Mod. X5) | Match Stainless-steel barrel, unfluted (Mod. X5)

- Mündungsdurchmesser: Ø32 mm
- Lauflänge: 81 cm / 86 cm / 91 cm
- Gewinde am Lauf: M25x1,5
- Kaliber / Calibre: 416 TYR / 416 Barrett / 460 Steyr / 50 Browning / 12,7x108

€ 2.989,80

Art.Nr.: WA2013-01-A0..

Matchläufe werden standardmäßig ohne Mündungsbremse und ohne Beschichtung geliefert.  
Match barrels as standard without muzzle brakes and without coating.

Unsere Modelle LBW, Tirolerin, VICTOR 3, ALPHA 3, S16 und K15A sind auch als Barreled Actions erhältlich. Diese können auch auf Kundewunsch konfiguriert werden.

Our Models LBW, Tirolerin, VICTOR 3, ALPHA 3, S16 and K15A are also available as Barreled Actions. They can also be configured to customer requirements.



### Mod. LBW - Barreled Action

Jagd-, Varmint- und Matchläufe / Hunting-, Varmint- and Match-barrels

ab / from € 1.993,20 | Art.Nr.: WA2003-00-00..



### Mod. VICTOR 3 - Barreled Action

KK-, Jagd-, Varmint- und Matchläufe / Rimfire-, Hunting-, Varmint- and Match-barrels

ab / from € 2.288,30 | Art.Nr.: WA2021-00-A002



### Mod. ALPHA 3 - Barreled Action

Matchläufe / Match-barrels

ab / from € 2.566,40 | Art.Nr.: WA2022-00-A001



### Mod. K15A - Barreled Action

K15A Standard, K15A Integral

ab / from € 399,- | Art.Nr.: WA2015-00-(A001-A002)



### Mod. S16 - Barreled Action

S16 Standard, S16 Integral, S16 Sport

ab / from € 645,70 | Art.Nr.: WA2016-00-(A001-A003)

## JAGDVISIERUNGEN | HUNTING SIGHTS

**1 Jagdvisierung** (Mod. LBW/2155/2165)  
**Hunting sight** (Mod. LBW/2155/2165)  
 € 89,90 | Art.Nr.: WZ98VI-10-B002

**3 Drückjagdschiene + Korn** (Mod. LBW/2155/2165)  
**Battue rail + front sight** (Mod. LBW/2155/2165)  
 € 96,30 | Art.Nr.: WA2155-10-0001

**5 Korn** (Zink-Druckguss / Mod. 2155/2165/2114/2185)  
**Front sight** (zinc die-cast / Mod. 2155/2165/2114/2185)  
 € 64,20 | Art.Nr.: WZ98VI-10-A007

**2 Leuchtvisierung** (Mod. LBW/2155/2165/Tirolerin)  
**Luminious sight** (Mod. LBW/2155/2165/Tirolerin)  
 € 96,30 | Art.Nr.: WZ98VI-10-B006 / WA2006-10-A001

**4 Edelstahl Korn** (Schiebevisierung / Makrolonkorn)  
**Stainless steel front sight** (tangent sight / Macrolon)  
 € 64,20 | Art.Nr.: WZ98VI-10-A008

**6 Zink-Druckguss Visier** (Mod. 2155/2165/2114/2185)  
**Zinc die-cast back sight** (Mod. 2155/2165/2114/2185)  
 € 64,20 | Art.Nr.: WZ98VI-10-A005



Ersatz für Makrolonkorn  
 Macrolon grain

**7 Schiebevisierungen** (Mod. VOERE KK)  
**Tangent sights** (Mod. VOERE KK)  
 € 89,90 | Art.Nr.: WZ98VI-10-A013 / WZ98VI-10-A012

**9 Edelmetallkorn** (Mod. VOERE KK)  
**Stainless steel front sight** (Mod. VOERE KK)  
 € 64,20 | Art.Nr.: WZ98VI-10-A010

**8 Kornsattel** (Mod. CZ 452)  
**Front sight base** (Mod. CZ 452)  
 € 64,20 | Art.Nr.: WZCZKK-10-B001

**10 Edelmetallkorn + Tunnel** (Mod. VOERE KK)  
**Stainless steel front sight + tunnel** (Mod. VOERE KK)  
 € 64,20 | Art.Nr.: WZ98VI-10-A011

**11 Korn + Kornsattel** (Mod. VOERE K15A)  
**Grain + grain saddle** (Mod. VOERE K15A)  
 € 53,50 | Art.Nr.: WA2015-10-B002

**12 Kimme kpl. (Visier)** (Mod. VOERE K15A)  
**Back sight** (Mod. VOERE K15A)  
 € 74,90 | Art.Nr.: WA2015-10-B001



VOERE LBW Luxus inkl. Zielfernrohr  
 VOERE LBW Deluxe incl. rifle scope

## SCHÄFTE | STOCKS

Wir bieten Jagdschäfte aus Holz, Schichtholz, Karbon und Kunststoff an. Unsere Schäfte werden bei uns im Haus entwickelt und bei uns im Unternehmen oder ausgewählten Qualitätsherstellern produziert. Außerdem beziehen wir Schäfte von anderen Herstellern, welche auf unsere Produkte abgestimmt sind.

*We offer hunting stocks made of wood, laminated wood, carbon and polymer. Our stocks are developed in-house and produced at our company or by selected quality manufacturers. We also source stocks from other manufacturers which are matched to our products.*

### MOD. LBW



**Walnussholzschafft, Schweinsrücken / Walnut stock, drop shape**  
Mod. LBW Standard / Luxus (Für Rechts- und Linksschützen / For right- and left handed shooters)  
€ 449,10 | Art.Nr.: WA2003-05-(A007/A008)



**Walnussholzschafft, Monte Carlo / Walnut stock, Monte Carlo**  
Mod. LBW Standard / Luxus (Für Rechts- und Linksschützen / For right- and left handed shooters)  
€ 534,70 | Art.Nr.: WA2003-05-(A009/A010)



**Walnussholzschafft Upgrade, Monte Carlo**  
**Walnut stock Upgrade, Monte Carlo**  
Mod. LBW Standard / Luxus  
€ 834,10 | Art.Nr.: WA2003-05-A011



**Walnussholzschafft - Stutzen, Monte Carlo**  
**Walnut stock - Full Stock, Monte Carlo**  
Mod. LBW Stutzen / Take Down  
€ 834,10 | Art.Nr.: WA2003-05-A012



**Schichtholzschafft, braun / Laminated wood stock, brown**  
Mod. LBW Standard / Luxus  
€ 513,30 | Art.Nr.: WA2003-05-A033



**Schichtholzschafft, multicolour / Laminated wood stock, multicolour**  
Mod. LBW Standard / Luxus  
€ 513,30 | Art.Nr.: WA2003-05-A032



**Schichtholzschafft, schwarz / Laminated wood stock, black**  
Mod. LBW Standard / Luxus  
€ 513,30 | Art.Nr.: WA2003-05-A031



**Emboss-olive (Beschichteter Holzschafft / synthetic coated wood stock)**  
Mod. LBW Standard / Luxus  
€ 449,10 | Art.Nr.: WA2003-05-A034



**Softtouch Schafft, schwarz / Softtouch stock, black**  
LBW Standard / Luxus (Nur für Varmintläufe geeignet! / Only suitable for varmint barrels!)  
Mod. LBW Standard / Luxus  
€ 449,10 | Art.Nr.: WA2003-05-A030

## IT`S MODULAR



**GRS Schichtholzschaff "HUNTER LIGHT"** (grey-black)  
*GRS-laminated wood stock "HUNTER LIGHT"* (grey-black)  
 Mod. LBW Luxus / Light-Varmint / Heavy-Varmint  
**€ 934,60** | Art.Nr.: WA2003-05-0055



**GRS Schichtholzschaff "SPORTER"** (grey-black)  
*GRS-laminated wood stock "SPORTER"* (grey-black)  
 Mod. LBW Light-Varmint / Heavy-Varmint / Match-Varmint  
**€ 934,60** | Art.Nr.: WA2003-05-0021



**Karbonfaserverstärkter Polymerschaff (Lochschaft)**  
*Carbon fibre reinforced polymer stock (thumbhole stock)*  
 LBW Light-Varmint / Heavy-Varmint / Match-Varmint  
**€ 934,60** | Art.Nr.: WA2003-05-A037



**Karbonfaserverstärkter Polymerschaff (Pistolengriff)**  
*Carbon fibre reinforced polymer stock (pistol grip)*  
 LBW Light-Varmint / Heavy-Varmint / Match-Varmint  
**€ 934,60** | Art.Nr.: WA2003-05-A038



**German Gun Stock (GGS) "REX" laminierter Epoxidharzschaff**  
*German Gun Stock (GGS) "REX" laminated epoxy resin stock*  
 LBW Light-Varmint / Heavy-Varmint / Match-Varmint  
**€ 1.338,-** | Art.Nr.: WA2003-05-0051



EXCLUSIVE FOR VOERE

## MODULARER POLYMERSCHAFT MODULAR POLYMER STOCK

- **Modular - Robust**
- **Upgradefähig** | upgradeable
- **Gewichtsreduktion** | weight reduction
- **Karbonfaserverstärkt** | Carbon fibre reinforced
- **Modelle: LBW/M2/X3** | Models: LBW/M2/X3
- **Höhen- und längenverstellbar**  
 Height- and length adjustable
- **2 Varianten** | 2 versions

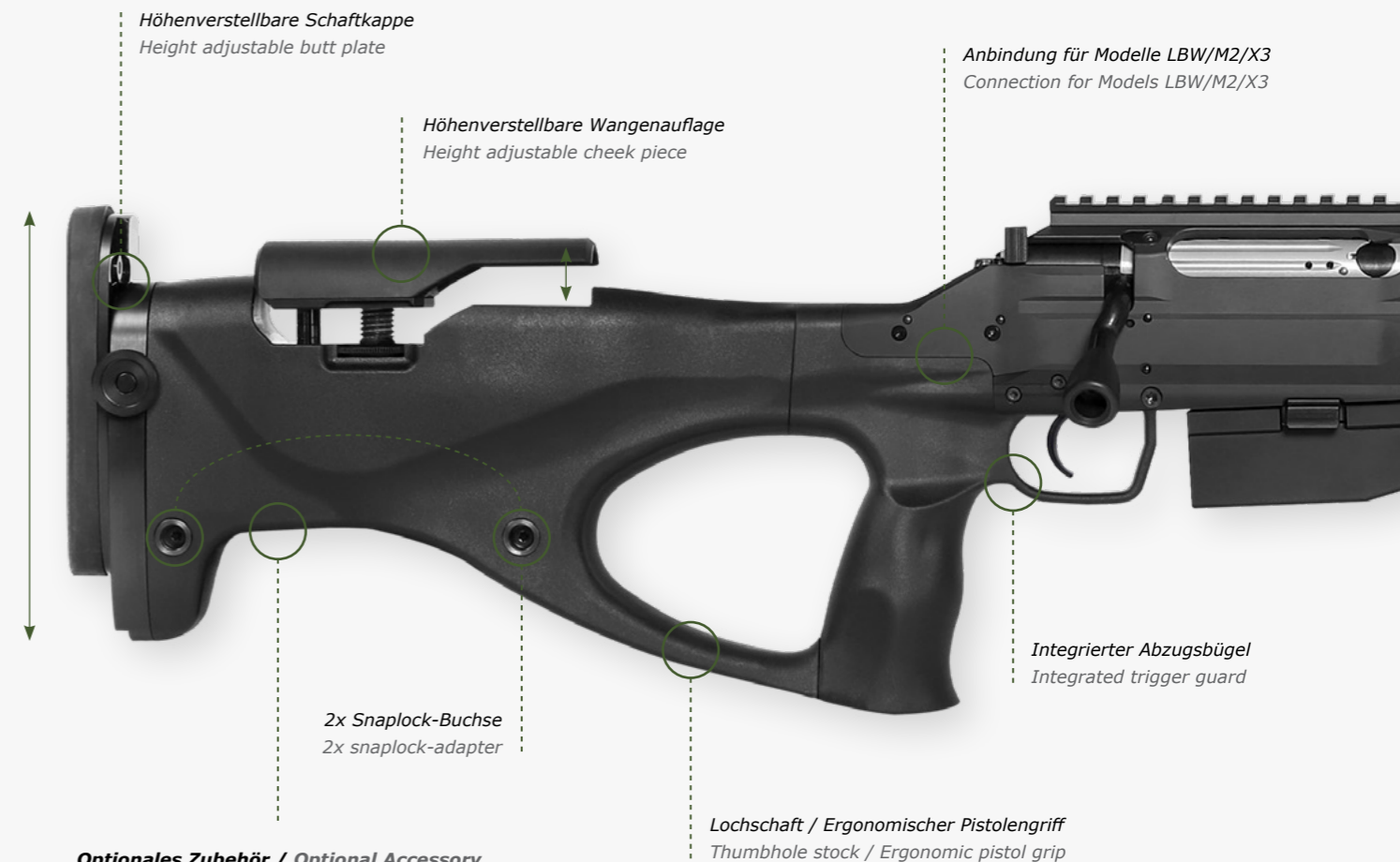

### Optionales Zubehör / Optional Accessory



Ersatzmagazinhalter  
 Spare magazine holder



Picatinny-Schiene  
 Picatinny-rail

**KARBONFASERVERSTÄRKTER HINTERSCHAFT**  
**CARBONFIBRE REINFORCED POLYMER REAR-STOCK**  
**€ 642,40** | Art.Nr.: WA2003-05-A035

## Mod. VICTOR 3

Passend für Remington 700® / Suitable for Remington 700®.



**HERA H7 Chassis**

Farben / Colours: Black, Tan, OD-Green

€ 398,- | Art.Nr.: WAHERA-05-(0001-0003)



**GRS "Berserk" Synthetiksschaft**

GRS "Berserk" synthetic stock

Preis auf Anfrage! / Price on request!



**MAGPUL® Hunter Polymerschaft**

MAGPUL® Hunter polymer stock

Preis auf Anfrage! / Price on request!

## Mod. 2155 | 2165



**Walnussholzsschaft, Schweinsrücken / Walnut stock, drop shape**

Mod. 2155 (für Rechts- und Linksschützen / For right- and left handed shooters)

€ 353,- | Art.Nr.: WA2155-05-(A001/A003)



**HOGUE**

**HOGUE Kunststoffschaft / HOGUE polymer stock**

Mod. 2155

€ 353,- | Art.Nr.: WA2155-05-A002



**Walnussholzsschaft, Monte Carlo / Walnut stock, Monte Carlo**

Mod. 2165

€ 449,10 | Art.Nr.: WA2165-05-0001

## Mod. Tirolerin



**Walnussholzsschaft, Monte Carlo / Walnut stock, Monte Carlo**

€ 513,30 | Art.Nr.: WA2006-05-A001



**Walnussholzsschaft, Schweinsrücken / Walnut stock, drop shape**

€ 577,50 | Art.Nr.: WA2006-05-A002

## Mod. K15A | S16



**Karbonfaserverstärkter Polymerschaft (K15A Standard | S16 Standard)**

Carbon fibre reinforced polymerstock (K15A Standard | S16 Standard)

€ 200,- / 250,- | Art.Nr.: WA2015-05-A002 / WA2016-05-A001



**Karbonfaserverstärkter Polymerschaft (K15A Integral | S16 Integral)**

Carbon fibre reinforced polymerstock (K15A Integral | S16 Integral)

€ 250,- | Art.Nr.: WA2015-05-A003 / WA2016-05-A002



## It's Modular The most modular system

Unsere Modelle LBW/M2/X3/X4/X5 bilden ein modulares System. Einzelne Teile wie Hinter- oder Vorder-schäfte können in den einzelnen Modellen getauscht werden. (z.B. Modell M2 mit X4/X5 Hinterschaft und X3 Vorderschaft lang)

Des Weiteren sind Picatinny-Schienen, Pistolengriffe, Läufe, Abzüge und Magazine in den Modellen LBW und M2 (X3) kompatibel.

*Our Models LBW/M2/X3/X4/X5 form a modular system. Individual parts such as rear- or front-stocks can be interchanged in the individual models. (e.g. Model M2 with X4/X5 rear-stock and X3 front-stock long).*

*Furthermore, Picatinny rails, pistol grips, triggers, barrels and magazines are compatible in the Models LBW and M2 (X3).*



### Mod. LBW Match-Varmint

223 Rem. - 338 Lapua Mag.



### Mod. M2

223 Rem. - 300 Win. Mag.



### Mod. X3

6.5x47 Lapua - 408 CT



### Mod. X4

300 Norma Mag. - 408 CT



### Mod. X5

416 Barrett - 50 Browning

## HINTERSCHÄFTE | REAR-STOCKS



### LBW Polymerhinterschaft (2 Varianten)

LBW polymer rear stock (2 versions)

Mod. LBW/M2/X3

€ 642,40 | Art.Nr.: WA2003-05-(A035/A036)



### M2/X3 Hinterschaft inkl. Längenverstellung

M2/X3 rear stock incl. length adjustment

Mod. LBW/M2/X3/X4/X5

€ 1.272,50 | Art.Nr.: WA2003-05-A001



### X4/X5 Hinterschaft inkl. Längenverstellung

X4/X5 rear stock incl. length adjustment

Mod. LBW/M2/X3/X4/X5

€ 1.484,10 | Art.Nr.: WA2013-05-A006

## PISTOLENGRIFFE | PISTOL GRIPS

### 1 VOERE Pistolengriff VOERE Pistol grip

€ 53,50

Art.Nr.: WA2012-05-B002

### 2 Pistolengriff mit Handballenauflage Pistol grip with palm rest

€ 148,40

Art.Nr.: WA2009-05-B024

### 3 Wechselbarer Pistolengriff CAA UPG16 Adjustable Pistol grip CAA UPG16

ab / from € 90,40

Art.Nr.: WA2009-05-B023



### Winterabzugsbügel Winter trigger guard

€ 85,50

Art.Nr.: WA2009-05-B004



## VORDERSCHÄFTE | FRONT-STOCKS

Alle Vorderschäfte der Modelle LBW/M2/X3 oder X4/X5 sind kompatibel und können in den einzelnen Modellgruppen getauscht werden.

**LBW/M2/X3 = 1|2|3|4|5 / X4/X5 = 6|7|8**

*All front-stocks of the Models LBW/M2/X3 or X4/X5 are compatible and can be interchanged in the individual model groups.*

**LBW/M2/X3 = 1|2|3|4|5 / X4/X5 = 6|7|8**



**LBW Polymer Vorderschaft**  
*LBW Polymer front-stock*  
**€ 146,10** | Art.Nr.: WA2003-05-0043



**M2/X3 Vorderschaft ohne Handschutz**  
*M2/X3 front-stock without hand guard*  
**€ 515,40** | Art.Nr.: WA2009-05-B002

**Verlängerung / extension**  
**€ 203,30** | Art.Nr.: WA2009-05-B015



**M2/X3 Vorderschaft mit Handschutz**  
*M2/X3 front-stock with hand guard*  
**€ 879,-** | Art.Nr.: WA2009-05-A011



**M2/X3 Vorderschaft lang mit Handschutz**  
*M2/X3 front-stock long with hand guard*  
**€ 1.103,70** | Art.Nr.: WA2009-05-A012



**M2/X3 Vorderschaft - POLICE EDITION**  
*M2/X3 front-stock - POLICE EDITION*  
**€ 278,-** | Art.Nr.: WA2009-05-A013



**X4/X5 Vorderschaft kurz ohne Handschutz**  
*X4/X5 front-stock short without hand guard*  
**€ 342,20** | Art.Nr.: WA2013-05-A002



**X4/X5 Vorderschaft lang ohne Handschutz**  
*X4/X5 front-stock long without hand guard*  
**€ 491,90** | Art.Nr.: WA2013-05-A007



**X4/X5 Vorderschaft lang mit Handschutz**  
*X4/X5 front-stock long with hand guard*  
**€ 919,60** | Art.Nr.: WA2013-05-B008

## TAKTISCHER TRAGEGRIF | TACTICAL CARRYING HANDLE



- Geeignet für Modelle M2/X3/X4/X5.
  - 2x Picatinny-Schienen
  - Snaplock-Adapter / Haltegriff / Metalldruck
- 
- Suitable for Models M2/X3/X4/X5.
  - 2x Picatinny-rails
  - Snaplock-Adapter / handle / metal print



**X3 mit Zubehör und Tragegriff**  
*X3 with accessories and carrying handle*

**€ 491,90**

Art.Nr.: WZTRAG-05-A001

## VOERE GEWEHRTASCHEN | VOERE RIFLE CASES

### wasserabweisend, stoßfest und stabil

zwei getrennte Fächer im Inneren, drei abnehmbare Außenfächer, Fixierungsmöglichkeiten, Tragegurt und Tragegriff, großes Außenfach, viele Verstellmöglichkeiten

### hydrophobic, shockproof and strong

two separate compartments inside, three removable pockets outside, fixation possibilities, carrying strap and handle, large outside bag, many adjustment possibilities

### Gewehrtaschen flat dark earth Small/Medium / Rifle Bags flat dark earth Small/Medium



#### Gewehrtasche Small / Rifle Bag Small

Maße / measurements: 1070 x 300 x 70 mm

Material: Polyester

€ 98,40 | Art.Nr.: WZKOFF-02-0008



#### Gewehrtasche Medium / Rifle Bag Medium

Maße / measurements: 1200 x 300 x 70 mm

Material: Polyester

€ 109,10 | Art.Nr.: WZKOFF-02-0009

### Gewehrtaschen coyote tan Small/Medium/Large / Soft Rifle Bags coyote tan Small/Medium/Large



#### Gewehrtasche Small / Rifle Bag Small

Maße / measurements: 1100 x 350 x 90 mm

Material: Polyester

€ 119,80 | Art.Nr.: WZKOFF-02-0011



#### Gewehrtasche Medium / Rifle Bag Medium

Maße / measurements: 1200 x 350 x 90 mm

Material: Polyester

€ 134,70 | Art.Nr.: WZKOFF-02-0012



#### Gewehrtasche braun Medium / Rifle Bag brown Medium

Maße / measurements: 1300 x 350 x 90 mm

Material: Polyester

€ 149,70 | Art.Nr.: WZKOFF-02-0013

### wasserdicht, hochwertig und robust

zwei Tragegriffe, wasserabweisende Imprägnierung und wasserdichte Reißverschlüsse, einsteckbare Schulterriemen, Beckengurt, Fixierungsmöglichkeiten (Klettverschlüsse)

### waterproof, high-quality and robust

two carrying handles, water-repellent impregnation and waterproof zippers, insertable shoulder straps, lap belt, attachment options (hook-and-loop fastener)



### Gewehrtasche Match - 110 cm / Soft Rifle Bag Match - 110 cm

Länge / length: ca. 110 cm

Höhe / height: ca. 35 cm

Material: Cordura 700

Farbe / colour: coyote tan

€ 288,80

Art.Nr.: WZKOFF-02-0006

#### Features:

zwei große Seitenfächer mit Innentaschen, einsteckbare Schulterriemen, Beckengurt, Fixierungsmöglichkeiten (Klettverschlüsse)

two large side pockets with inside pockets, insertable shoulder straps, pelvic belt, fixing options (Velcro fasteners)



### Gewehrtasche Match - 110 cm / Soft Rifle Bag Match - 110 cm

Länge / length: ca. 140 cm

Höhe / height: ca. 40 cm

Material: Cordura 700

Farbe / colour: coyote tan

€ 192,50

Art.Nr.: WZKOFF-02-0007

#### Features:

drei große Außenfächer für den Transport von Zubehör, kleine Innentaschen

three large outside pockets for transporting accessories, small inside pockets



### LBW Take Down Koffer / LBW Take Down case

**Mod. LBW Take Down / Hardcase + EVA-Inlay**  
 Länge / length: ca. 92 cm      Farbe / colour: schwarz / black  
 Höhe / height: ca. 39 cm      Breite / width: 13 cm

€ 278,00 | Art.Nr.: WZKOFF-01-0002

## MODULARES TASCHENSYSTEM | MODULAR CASE SYSTEM

Ein **MODULARES TASCHENSYSTEM** ist für unsere Präzisionsgewehre M2, X3, X4 und X5 erhältlich. Das Softcase mit Inlay ist für alle unsere Präzisionsgewehre geeignet. Zudem bieten wir einen Transportkoffer Hardcase an, welcher ebenfalls für alle Modelle verfügbar ist. Das Inlay ist auf beide Koffer abgestimmt und kann mit einfachen Handgriffen vom Softcase in den Hardcase, oder umgekehrt, getauscht werden.

The **MODULAR CASE SYSTEM** for our precision rifles M2, X3, X4 and X5 is available now. The softcase with inlay is suitable for all our precision rifles. Furthermore we offer a transport Hardcase, which is also available for all models. The two cases are designed for each other. That means that the inlay can be easily exchanged from the softcase to the Hardcase, or vice versa.



### Gewehrkofer Jagd / Guncase Hunting

Alle Jagdmodelle / All hunting models / Hardcase  
 Länge / length: ca. 120 cm      Farbe / colour: schwarz / black  
 Höhe / height: ca. 25 cm      Breite / width: 12 cm

€ 68,50 | Art.Nr.: WZKOFF-01-0003



### Softkoffer inkl. Inlay / Softcase incl. Inlay

**Mod. M2/X3/X4/X5** | Polyester + EVA-Inlay

Länge / length: ca. 132 cm      Farbe / colour: schwarz / black  
 Höhe / height: ca. 38 cm      Breite / width: 20 cm



### Transportkoffer Hardcase inkl. Inlay / Transport Hardcase incl. inlay

**Mod. M2/X3/X4/X5** | Hardcase + EVA-Inlay

Länge / length: ca. 140 cm      Farbe / colour: schwarz / black  
 Höhe / height: ca. 44 cm      Breite / width: 17 cm

Art.Nr.: WZKOFF-01-A002

€ 898,20



### Gewehrkofer Match / Guncase Match

Mod. LBW Match-Varmint, M2, X3 / Hardcase  
 Länge / length: ca. 130 cm      Farbe / colour: schwarz / black  
 Höhe / height: ca. 35 cm      Breite / width: 15 cm

€ 74,90 | Art.Nr.: WZKOFF-01-0004

Art.Nr.: WZKOFF-04-0005

€ 427,70



### Take Down Tasche / Take Down case

Mod. Tirolerin / Softcase + EVA-Inlay  
 Länge / length: ca. 92 cm      Farbe / colour: schwarz / black  
 Höhe / height: ca. 34 cm      Breite / width: 14 cm

€ 203,30 | Art.Nr.: WZKOFF-01-0001

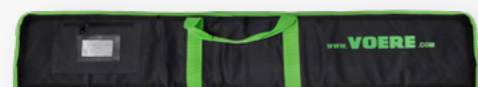

### Gewehrtasche schwarz-grün / Rifle bag black-green

Länge / length: ca. 110 cm      Farbe / colour: schwarz-grün / black-green  
 Höhe / height: ca. 22 cm      Material: Polyester

€ 42,80 | Art.Nr.: WZKOFF-05-0001

## WAFFENZUBEHÖR | RIFLE ACCESSORY

Außerdem bieten wir diverses Zubehör für verschiedene Anwendungen an. Zu unserem Waffenzubehör gehören Pistolengriffe, Biathlonriemen und vieles andere.

*We also offer other accessories for different applications. These include pistol grips, sling bars, biathlon straps and much more.*



**VOERE Drehmomentschlüssel 2,2 Nm | 4 Nm | 5,7 Nm | 10 Nm**  
**VOERE torque wrench 2,2 Nm | 4 Nm | 5,7 Nm | 10 Nm**

€ 29,90 | Art.Nr.: WZWKZG-01-00..



**Flimmerband inkl. Adapter / Mirage band incl. adapter**

Mod.: LBW/M2/X3/X4/X5

€ 53,50 | Art.Nr.: WZFLIM-01-A001

**Reinigungsset (Karbon-Putzstock, Bürsten + Patchhalterspitze)**  
**Cleaning set (carbon-cleaning rod, brushes + patch holder tip)**  
 Kaliber / calibre: .308 / .338 / .408

€ 110,80 | Art.Nr.: WZREIN-01-A00.



## TRAGERIEMEN - TRAGEGURTE | CARRYING BAG - SLINGS

Der Biathlonriemen wird mit Hilfe von Riemenbügeln an der Waffe befestigt. Dazu werden Snaplock Buchsen benötigt, welche bei unseren Modellen K15A, S16 und den Präzisionsgewehren standardmäßig verbaut sind.

*The biathlon sling is attached to the weapon with the help of sling swivels. This requires snaplock adapters, which are standard on our K15A, S16 and precision rifles.*



**Hülsenfangsack für Mod. X3**  
**Brass catcher for Mod. X3**

€ 256,60 | Art.Nr.: WA2012-05-A005

**Falsches Schloss für Mod. X3/X4**  
**Cleaning rod bore guide for Mod. X3/X4**

€ 74,90 | Art.Nr.: WA2012-03-00.. / WA2013-03-0039



**Biathlonriemen inkl. Snaps**  
**Biathlon sling incl. snaps**

€ 53,50 | Art.Nr.: WZSONS-03-0013



**Push Button Riemenbügel (2 Stück)**  
**Sling swivel push button (2 pieces)**

€ 32,20 | Art.Nr.: WZRIEM-01-0008



**Set abnehmbare Riemenbügel (2 Stück)**  
**Set of detachable swivel rings (2 pieces)**

€ 32,20 | Art.Nr.: WZRIEM-01-A003

## BE A PART OF THE VOERE-TEAM

**BE A PART OF THE VOERE-Team** und werde Mitglied unserer Community. Viele tolle Merchandising Produkte stehen bei uns zur Verfügung. Von T-Shirts über Fleecejacken bis hin zu Trinkflaschen sind bei uns erhältlich.

**BECOME PART OF THE VOERE-TEAM** and become a member of our community. Many great merchande products are available. T-shirts, Fleece jackets and bottles are available.



1 T-Shirt grau / T-Shirt grey  
€ 17,90 | Art.Nr.: WZSONS-01-0023



2 Polo T-Shirt grau / Polo T-Shirt grey  
€ 21,90 | Art.Nr.: WZSONS-01-0024



3 Softshelljacke schwarz / Softshelljacket black  
€ 49,90 | Art.Nr.: WZSONS-01-0022



4 Zielscheibe 100 m (10 Stück) / Target 100 m (10 pieces)  
€ 5,- | Art.Nr.: WZSONS-01-0008

5 Zielscheibe 500 m (10 Stück) / Target 500 m (10 pieces)  
€ 15,- | Art.Nr.: WZSONS-01-0006

6 Zielscheibe 600 m (10 Stück) / Target 600 m (10 pieces)  
€ 15,- | Art.Nr.: WZSONS-01-0007

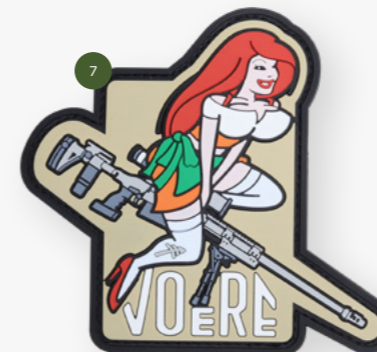

7 Patch Frau / Patch Girl  
€ 7,90 | Art.Nr.: WZSONS-01-0025



8 Patch Logo grün / Patch Logo green  
€ 3,90 | Art.Nr.: WZSONS-01-0016



9 Schlüsselanhänger Frau / Key chain girl  
€ 3,90 | Art.Nr.: WZSONS-01-0018



11 Aluminium Trinkflasche / Aluminium bottle  
€ 9,90 | Art.Nr.: WZSONS-01-0007



10 Schlüsselanhänger / Key chain  
€ 3,90 | Art.Nr.: WZSONS-01-0017



12 Tasse, gefrostet / Cup, frosted  
€ 6,90 | Art.Nr.: WZSONS-01-0001



13 Tasse, weiß / Cup, white  
€ 6,90 | Art.Nr.: WZSONS-01-0002



14 Sitzkissen / Seat pillow  
€ 7,90 | Art.Nr.: WZSONS-01-0009



15 Sandsack (klein) / Sandbag (small)  
€ 7,90 | Art.Nr.: WZSONS-01-0021

16 Sandsack (groß) / Sandbag (big)  
€ 10,90 | Art.Nr.: WZSONS-01-0020



[www.VOERE-SHOP.com](http://www.VOERE-SHOP.com)



In unserem neuen **VOERE WEBSHOP** finden Jäger und Sportschützen alles was Ihr Herz begehrt. Unser Shop wurde auf Wunsch unserer Händler erstellt und soll vor allem unsere Produktpalette zeigen und einen Überblick geben. Außerdem sollen Kunden animiert werden, Produkte bei unseren Händlern zu bestellen oder zusätzliche Informationen bei uns anzufragen.

*In our new **VOERE WEBSHOP** hunters and marksmen find everything their heart desires. Our shop was created by the request of our dealers and is mainly intended to show our product range and give an overview. Furthermore customers should be encouraged to order products from our dealers or request additional information from us.*

[www.voere-shop.com](http://www.voere-shop.com)

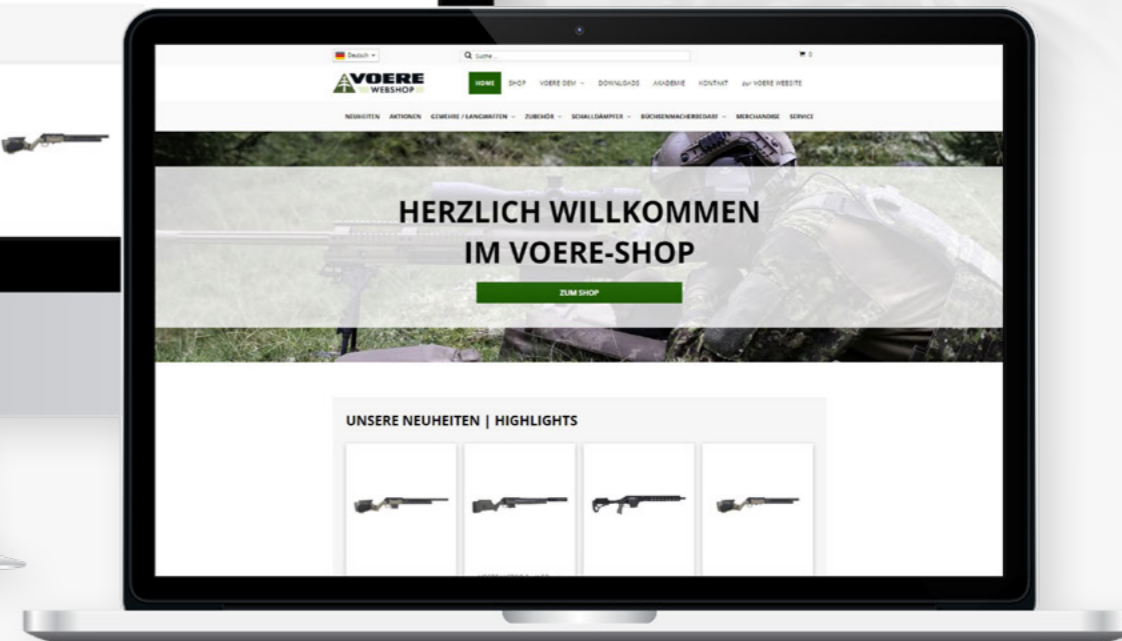
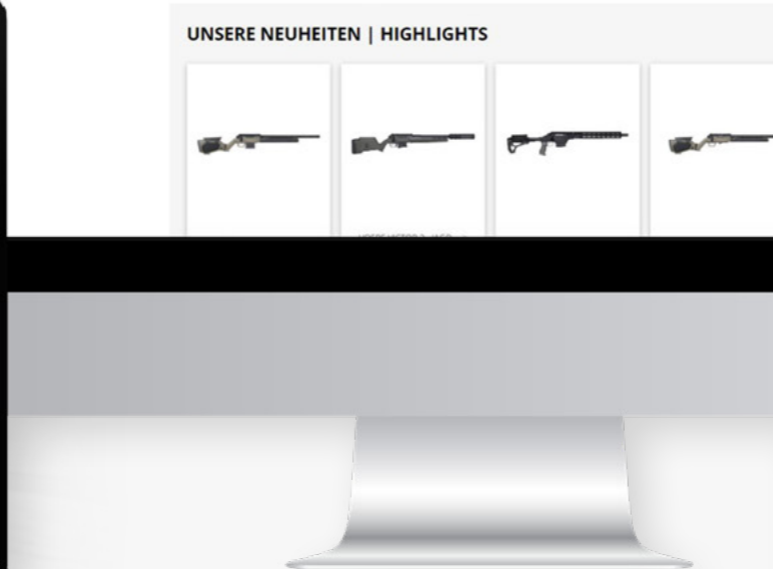
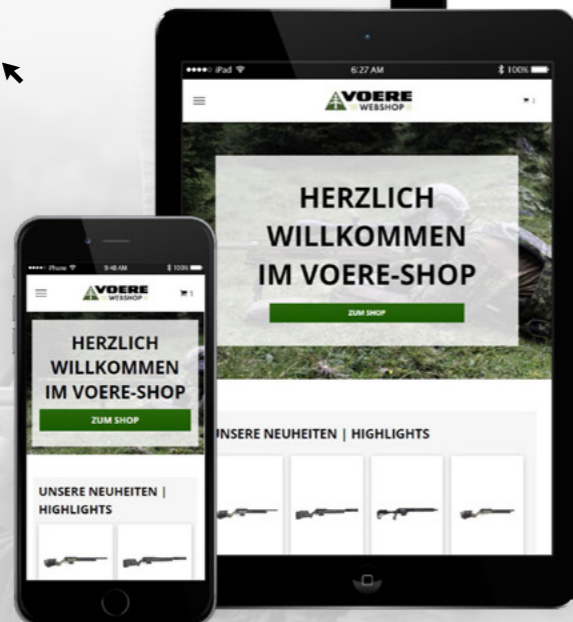
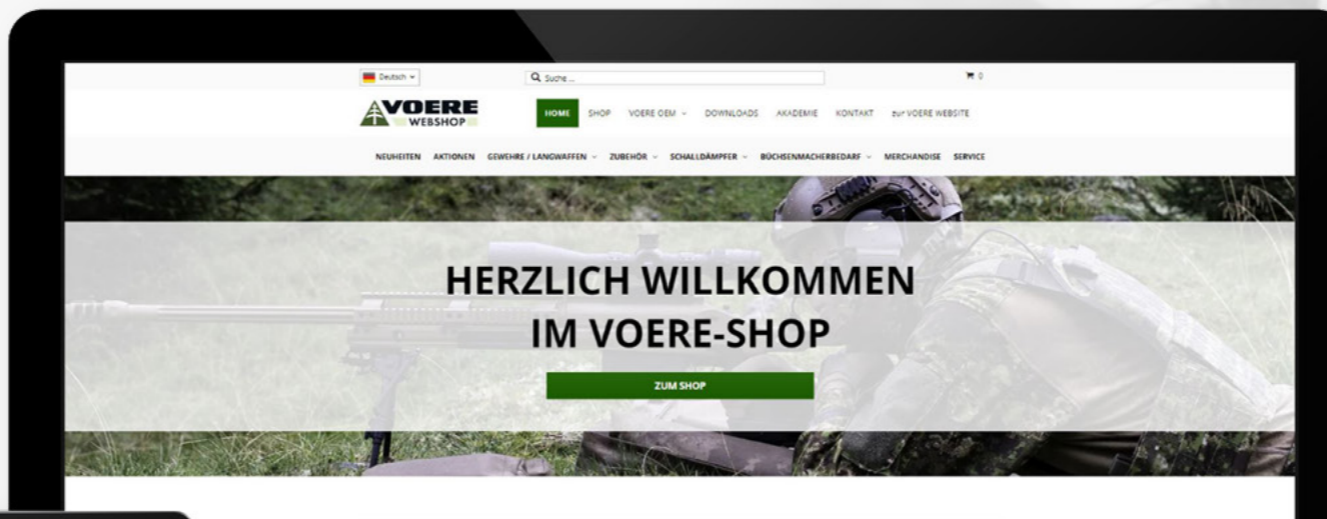

## HIGH-TECH SCHAFFT HÖCHSTE PRÄZISION HIGH-TECH CREATES HIGHEST PRECISION

Neben Sport- und Jagdwaffen produzieren wir hochpräzise Teile für Luftfahrt, Elektronik-, Glaswaren- und Automobilindustrie

Des Weiteren haben wir seit über 10 Jahren eine technologische Vorreiterrolle als leistungsstarker Systemtechnikpartner bei der Produktion von mechanischen, mechatronischen und systemtechnischen Baugruppen eingenommen.

Wir verfügen über einen höchst modernen Maschinenpark mit Hochgeschwindigkeitsbearbeitung bis zu 10 Achsen. Nicht ohne Grund fertigen wir auch in einer 2. Sparte erfolgreich Produkte für die Medizintechnik und optische Industrie.

*We produce high-precision parts for the aerospace, electronics, glassware, automotive industries, as well as mechanical engineering.*

*Furthermore, for more than 10 years, we have taken a technological pioneering role as high-performance system technology partner in production of mechanical, mechatronical and system assemblies.*

*We have a high modern machinery offering high speed machining in up to 10 axes. We have a second business division that successfully manufactures precision components for the medical and optical industry.*



**VOERE 2114/2115**

*Kleinkaliber-Halbbautomat  
Rimfire semi-automatic rifle*



**VOERE 2185**

*Selbstladebüchse in elegantem Design  
Semi-Automatic rifle in elegant design*



**VOERE AM180**

*Erstes Maschinengewehr mit Laserzieleinrichtung  
First machine gun with laser aiming device*



**VOERE**

**WHEN PRECISION MATTERS**

[www.voere-shop.com](http://www.voere-shop.com)

### IMPRESSUM / IMPRINT

**Ausgabe / Edition:** **PRODUKTE** - Sechste Auflage | **PRODUCTS** - Sixth Edition

**Herausgeber / Publisher:** **sr-enterprise.at GmbH**  
Untere Sparchen 56 • 6330 Kufstein | Österreich  
Tel.: +43 5372 62547  
Fax: +43 5372 65752  
E-Mail: [service@voere.at](mailto:service@voere.at)  
Internet: [www.voere.com](http://www.voere.com) • [www.voere-shop.com](http://www.voere-shop.com)

**Erscheinung / Publication:** 08/2022

Alle in diesem Katalog enthaltenen technischen Angaben, Beschreibungen und Abbildungen sind unverbindlich, Änderungen und Irrtümer vorbehalten.

Für etwaige Druckfehler übernehmen wir keine Haftung. Zur Abrechnung kommen die am Tage des Auftragseingangs gültigen Preise. Lieferungen gelten nur für unser Haus geltenden »AGB - Allgemeinen Geschäftsbedingungen«. Durch Erscheinen dieses Katalogs werden alle früheren Kataloge ungültig.

© **sr-enterprise.at GmbH**  
Stand 08/2022

*All technical data, descriptions and illustrations contained in this catalogue are non-binding, subject to change and errors.*

*We assume no liability for any printing errors. The prices valid on the day the order is received will be invoiced. Deliveries are only valid for our „General Terms of Business“. By publication of the catalogue all previous catalogues become invalid.*

[www.voere-shop.com](http://www.voere-shop.com) 

[www.VOERE-SHOP.com](http://www.VOERE-SHOP.com)



Untere Sparchen 56 • 6330 Kufstein | Österreich  
Tel.: +43 5372 62547 • Fax: +43 5372 65752  
office@voere.at • www.voere.com  
[www.voere-shop.com](http://www.voere-shop.com)

