

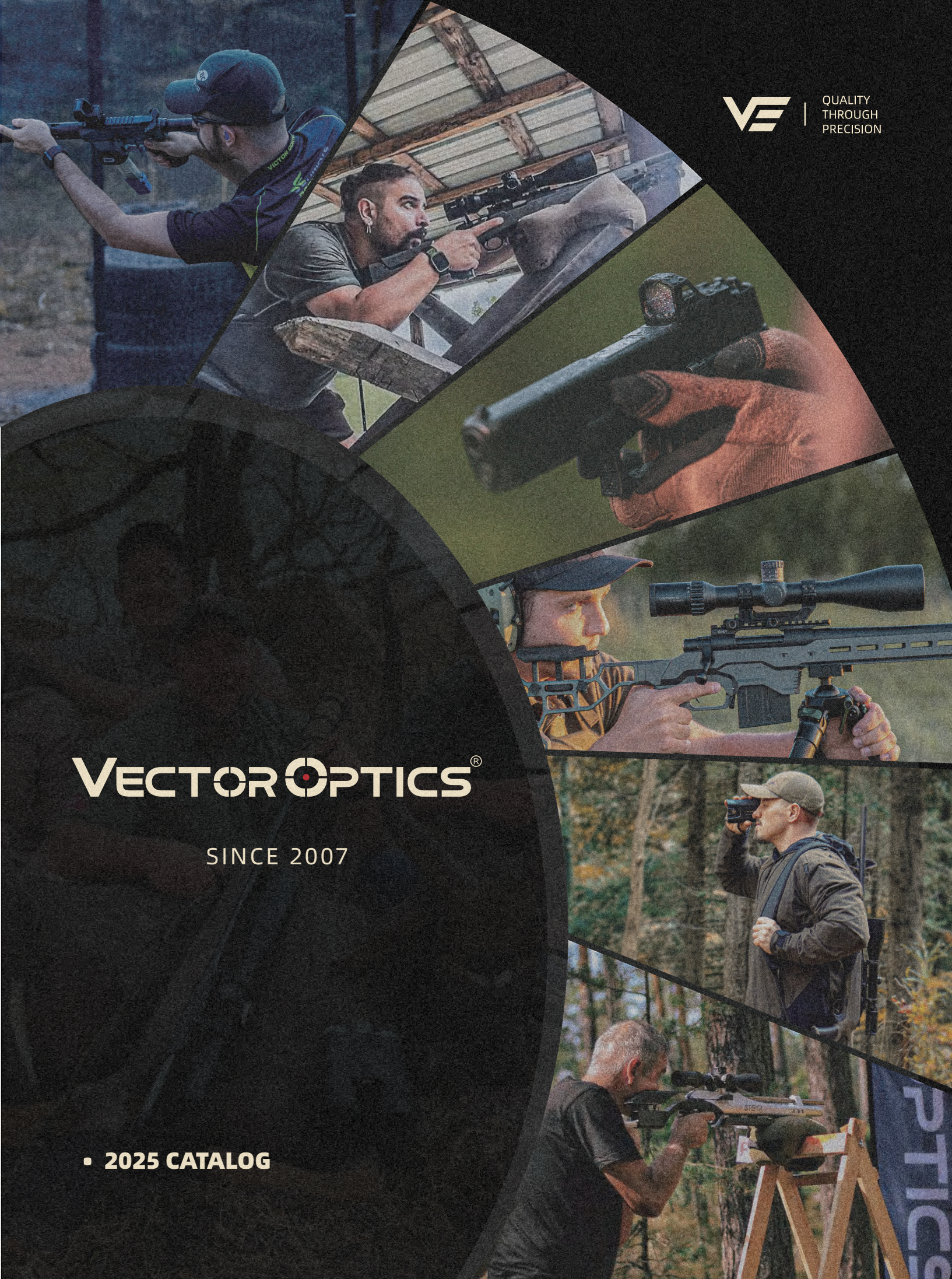

QUALITY
THROUGH
PRECISION



VECTOR OPTICS®

SINCE 2007

• 2025 CATALOG

QUALITY THROUGH PRECISION

Vector Optics Has Provided Premium Optics And Innovative Sighting System For More Than 16 Years.

We Design, Build, And Test Our Scopes & Red Dot Sights For Rifles And Pistols To Be Used In All Fields Of Applications For Hunting, Defense, Sporting & Competition.

We Build Our Products Beyond Expectations. We Provide Precision Aiming Solutions And Perfect Shots Over Short, Medium, And Long Range Shooting.

Our Products Are Implemented In Various Applications From Recreational Shooters To Critical Users Such As Sporting Marksmen, Avid Hunters, And Tactical Elites In Arctic Cold, Desert Heat, And All In Environments That Can-And-Will.

Vector Optics Will Accompany Your Every Shot And Be Your Loyal Partner!

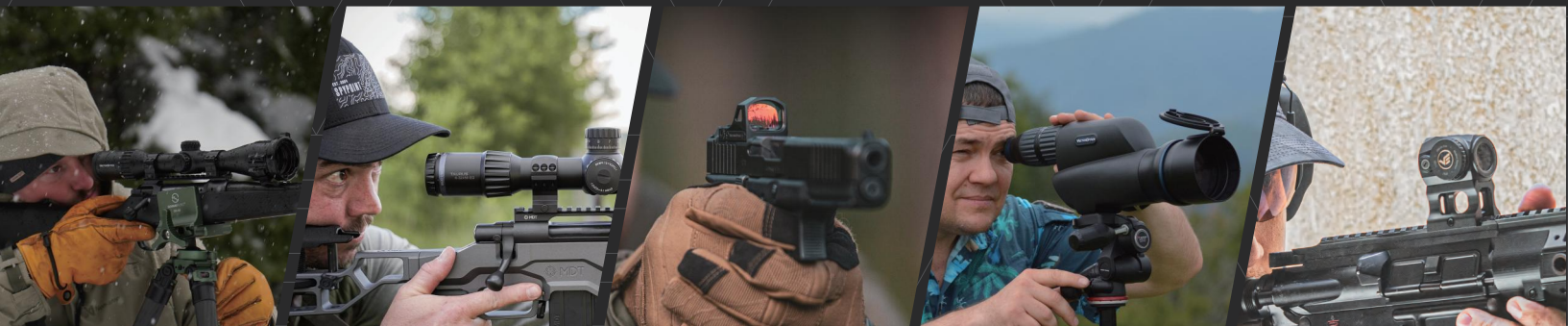

The "T" stands for Tailored. Vector Optics products are built to meet your expectation. If your Vector Optics falls short, we are always here to help you.

Continental, Tauron, Scrapper, Paragon, and Frenzy line products are covered by our T-VIP lifetime warranty. We will, at our option, either repair or replace your Vector Optics product without any cost if it is damaged or defective. If we can't repair your damaged product, we will replace it with a brand- new one in better condition.

You have our word that we will always take care of you and support you. You can count on our T-VIP lifetime warranty.

T-VIP lifetime warranty covers:

- ① Fully transferable;
- ② Free repair or replacement;
- ③ No invoice or receipt is needed;
- ④ We pay the shipping back cost;
- ⑤ We guarantee a response within 24 hours.

No questions asked though we value your feedback.

This warranty does not cover product loss, theft, deliberate damage, abuse, misapplication, or modification.

This warranty does not apply to the electronic components or batteries.

If you have more questions, please contact our customer service department via service@vectoroptics.com. If you need to return the product, insure your shipment and keep the tracking records. We are not responsible for your product until we receive it.



Vector Optics products are built to meet your expectation. If your Vector Optics falls short, we are always here to help you.

In the event of a defect under this warranty, we cover free repair or replacement, for a period of five years from the date of purchase.

This warranty is not transferrable.

This warranty does not apply to the electronic components or batteries.

This warranty does not cover product loss, theft, deliberate damage, abuse, misapplication, or modification.

This warranty is null and void if any modification or maintenance is performed by a party other than Vector Optics.

If you have more questions, please contact our customer service department via service@vectoroptics.com.

If you need to return the product, insure your shipment and keep the tracking records. We are not responsible for your product until we receive it.

If you do not purchase the product from vector2007.com, contact your local dealer for applicable warranty information.

Kindly take a moment to register your new Vector Optics product to activate your 5-year warranty. This registration provides convenient access to all your product information with just a click.

We appreciate your understanding and support. Be Safe and Have Fun!



VISIT US ON



VectorOptics



VictOptics



Owlset



- 2 About VectorOptics
- 3 Warranty
- 4 Visit Us

RIFLESCOPES

Top Line

- 12  Continental

Premium Line

- 26  Tauron

- 30  Paragon

Classic Line

- 34  Constantine

- 36  Orion

- 38  Veyron

- 50  Grizzly

- 52  Mustang

- 53  Forester

RED DOTS

- 56  Frenzy

- 66  Scrapper

- 70  Nautilus

- 74  Maverick

- 78  Omega

OTHER OPTICS

- 80 Magnifier

- 84 Binocular

VICTOPTICS

- 94 RifleScope

- 106 Red Dots

- 109 Mount

- 110 Binocular

- 110 Spotting Scope

- 110 Range Finder

- 110 Scope Collimator Instrument

112 GUNPANY

- 116  Rokstad

- 122  VipeRay

- 126  X-ACCU

- 138  Owlset

TABLE OF CONTENTS

- 40  Minotaur

- 42  Hugo

- 44  Matiz

Entry Line

- 48  Sentinel

- 89 Spotting Scope

- 90 Range Finder

- 91 Monocular

SCOPE OPTICS FEATURES

N2

Nitrogen Purged

Prevent internal fogging for clear visibility

IPX4

IPX4 Water Resistance

IPX4 can withstand water splashing from any direction, providing protection against light rain or water splashes

IP67

IP67 Water Proof

Dust-tight & waterproof in 1 meter deep for 30 min

1000G

Shock Proof - Built to Endure

Endure physical shock, impacts or vibrations



Compact Design

Easy handling and portability

**TUBE
MM**

25.4mm / 30mm / 34mm Tube Size

25.4mm tube lightweight and compact design
30mm large to increase the adjustment range
34mm extra large to maximize the adjustment range

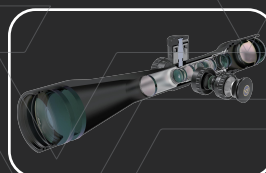

SCOPE BODY

OBJECTIVE LENS

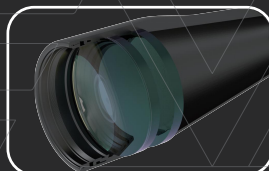

Muti-Coated

A multi-coated lens enhances light transmission, reduces reflections and scattering. These enhancements boost the clarity and brightness of the target image

Fully Muti-Coated

Fully multi-coated lens reduce glare & reflection and improve light transmission & color contrast. It makes the image appear sharp and bright even in low-light conditions

ED GLASS

ED glass minimizes chromatic aberrations with 93% light transmission rate, resulting in stunning sharpness and contrast, even at maximum magnification

HD Glass

HD(High Definition) glass refers to optical glass reducing chromatic aberration and providing superior clarity, resulting in sharp, clear, vivid images

LaREE HD Glass

The HD glass made with advanced LaREE (Lanthanide Rare Earth Element) lenses, delivering superior clarity and brightness and vividness.



Light Transmission

90%: crisp and sharp image with details
93%: ensure crystal clear image



VePRO™ FMC

VePRO FMC stands for vector premium reliable optoelectronic fully multi-coated; a cutting-edge coating technology used in VE in-house lab, maximizing light transmission exceeding 90%

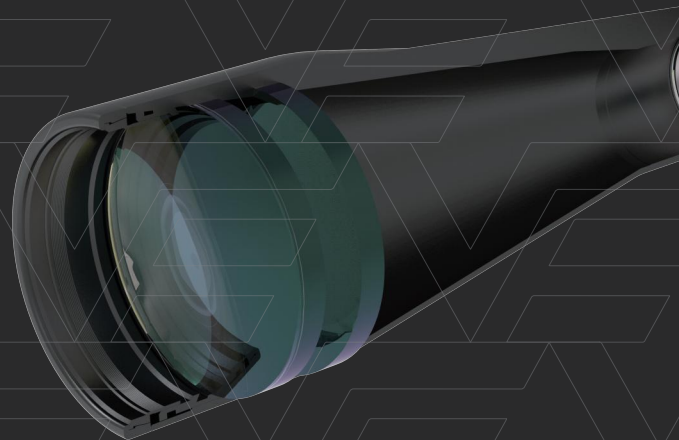



Turret Lock

Prevent unwanted adjustments



Set Zero Position

Set new zero position anytime



Zero Stop

Effortlessly return to pre-set zero

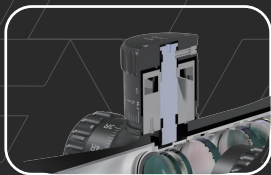

ADJUSTMENT



High Performance Adjustment

Finely tuned mechanisms for precise control



Audible Mechanical Clicks

Audible Mechanical clicks for elevation and windage adjustments. Precisely know your click value for each adjustment, easy to remember and adjust



Revolution Indicator Mark

It visually indicates the number of full rotations made on turrets, tracking adjustments accurately and prevent confusion over multiple revolutions, especially crucial for long-range shooters

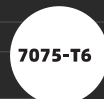

7075-T6 Aluminum Housing

Ultra-lightweight, stable and durable

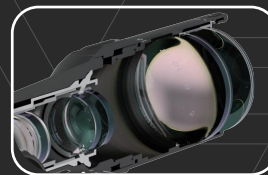
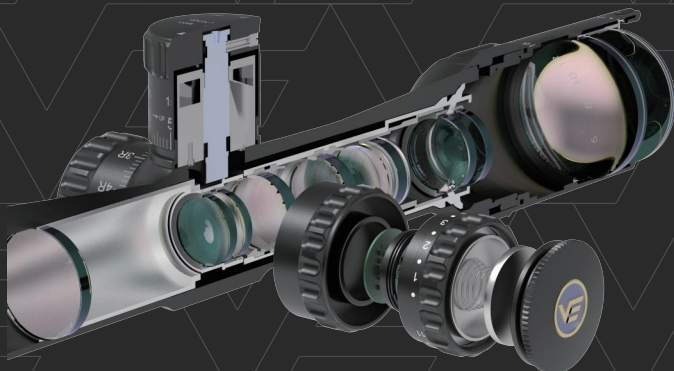

OCULAR LENS



Zoom Factor

Zoom factor enables adaptive shooting



Edge-to-Edge Clarity

The feature ensures consistent sharpness and clarity across entire field of view, including the periphery of the image. Little distortion image enhances precise visual assessment and overall viewing comfort.



Hunting Style & Tactical Style

Different design and functionality options for specific shooting purposes.



Extra Large Eye Box

More forgiving eye positioning



FFP & SFP

FFP: reticle Changes Along with Magnification
SFP: consistent reticle with varying magnification



Long Eye Relief

Ensure safety & gain situational awareness



1x With Both Eyes Open

1X enables both eyes open for an easier aiming



SIDE FOCUS & ILLUMINATION



Parallax Adjustment

The feature corrects the apparent shift of the reticle relative to the target when the viewer's eye moves off-center from the eyepiece



Side Focus

Side Focus allows for precise focus and eliminates parallax error at various distances, as close as 10 yards, providing greater versatility and accuracy from short to long range.



X Level Illumination

Selectable multi-level illumination intensities enhance reticle visibility, adapting to a variety of lighting conditions



Fiber Optic Illumination

Advanced visibility even in bright light conditions

RED DOT OPTICS FEATURES

OBJECTIVE LENS



Muti-Coated

A multi-coated lens enhances light transmission, reduces reflections and scattering. These enhancements boost the clarity and brightness of the target image



Parallax Free

Point of Aim Aligns with Point of Impact

OCULAR LENS



Aspheric Lens

Present distortion-free image with sharp reticle



Large Window

A large window provides an expansive viewing area, enhancing visibility and easing target acquisition by offering a broader field of view and allowing shooters to maintain sight of the dot.

DIGITAL CIRCUIT



Motion Sensor

Effortless Activation and Battery Savings



LED Emitters

The Direct Light Source (RCLED) minimizes astigmatism and provides a more rounded dot. It offers greater stability and is more energy-efficient than traditional aperture hole light sources.



Automatic Light-sensitive Sensor

Automatically Adjust the Reticle Brightness



Dot Size

2,3MOA: Small Size for Precision over Long Distance
5,6MOA: Large Size for Rapid Target Acquisition

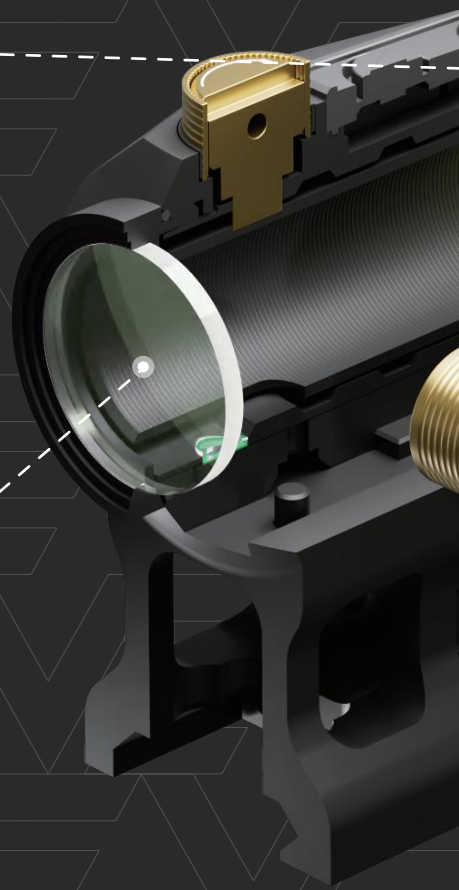



SCOPE BODY

N2

Nitrogen Purged

Prevent Internal Fogging for Clear Visibility



IPX4 Water Resistance

IPX4 can withstand water splashing from any direction, providing protection against light rain or water splashes



IP67 Water Proof

Dust-tight & waterproof in 1 meter deep for 30 min



Shock Proof - Built to Endure

Endure Physical Shock, Impacts or Vibrations



Lightweight Design

Lighten your load, aim with ease



Side-load Battery Tray

It is convenient and quick to change the battery, without re-zeroing each time, especially useful during the competition or some emergent situation



Quick Release Picatinny Mount

Quickly secure and uninstall optic

ADJUSTMENT & FUNCTION



Audible Mechanical Clicks

Perceptible to Adjust



Multi-Reticle

Dot Reticle, Crosshair Circle and Crosshair Circle with Dot Reticle



Solar Panels

Eco-friendly & Long-lasting Performance



NV-Compatible Red Dot

NV Illumination for Take Shot at Night



Illumination

Illumination improves reticle visibility in different light conditions, especially when light is limited.

— TOP LINE —



TOP LINE

Lifetime Warranty



CONTINENTAL[®]



CONTINENTAL[®], our high-end riflescope, features a Professional-Grade Optical System, excelling in challenging lighting conditions and offering unmatched light transmission.

Designed for professional shooters, this line ensures superior quality and includes a lifetime warranty for your peace of mind. Experience top performance with our premier product.





















Outstanding clear glass to see detail very well at long distances which makes it easy to identify targets or to see bullet impact. The turrets are the best features, they have a ton of adjustment, super crisp, very positive and very audible and with a Zero stop turret included.

Overall, from the ocular focus, zoom ring, turrets and side focus wheel there is No slop or play which makes this scope the best value for money.

The reticle comes with a ton of holdover indications and just the right thickness.

Marno Denner
South Africa

FEATURES

-  High Precision Adjustment
-  7075-T6 Aluminum Housing
-  Big Game Hunting
-  VePRO™ FMC
-  LaREE HD Glass
-  CQB Environment
-  90° Light Transmission
-  Extra Large Eye Box (EPVO)
-  Safari Hunting
-  Zero Stop
-  Turret Lock
-  3-Gun Competition
-  Set Zero Position
-  Scope Revolution Indicator
-  Dangerous Game Hunting
-  IP67 Water Proof
-  1000G Shock Proof Built to Endure
-  Law Enforcement
-  Edge-to-Edge Clarity
-  With Rings
-  Mountain Hunting
-  Lens Cover
-  Tube Sunshade

RETICLE PATTERN

-  VCT-BNWX (MIL)
-  VCT-34FFP (MIL)
-  VEC-MBR (MIL)
-  VET-CTR 2 (MIL)
-  VET-RAR 2 (MIL)
-  VCO-8 MIL (MIL)



Power ring throw lever (SCCON-TL)



Parallax big side wheel genll (SCCON-SW2)



Metal flip-up cap

CONTINENTAL® 34MM HD

It delivers an unparalleled vision and extremely high volume adjustment range. Each of these models provides Zero Stop with a revolution counter system.

Robust, Relentless, Remarkable.



1-6x28 FFP

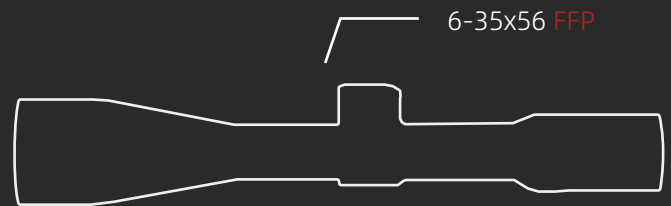

6-35x56 FFP



SKU	NAME	RETICLE	ILLUMINATION	EYE RELIEF (mm / in)	F.O.V (m @100 Meters) (ft @100 Yds)	ADJUSTMENT RANGE	TUBE SIZE	LENGTH (mm / in)	WEIGHT (net)(g / oz)	CLICK VALUE	PARALLAX ADJUSTMENT
SCFF-31	1-6x28 FFP	VCT-BNW	6 levels R		40.8-6.8 112.5-20.4	45MIL(E) 20MIL(W)		296 / 11.7	550 / 19.4		100yds
NEW SCFF-67	2-12x44 CTR FFP	VEV-CTR 2				65MIL(E) 30MIL(W)		315 / 12.4	767 / 27.0		
NEW SCFF-69	2-12x44 RAR FFP	VEV-RAR 2	11 levels R		18.0-3.6 54.0-10.8	55MIL(E) 30MIL(W)					
SCFF-28		VCT-34FFP							820 / 28.9		
SCFF-43	3-18x50 FFP	VEC-MBR			13.6-2.3 40.8-6.8	34MIL(E) 16MIL(W)		337 / 13.3	790 / 27.9		
SCFF-29		VCT-34FFP		100 / 4.0			34mm		780 / 27.5	1/10MIL	10yds to ∞
SCFF-40	4-24x56 FFP	VEC-MBR	6 levels R		10.2-1.7 30.6-5.1	34MIL(E) 16MIL(W)		362 / 14.3	855 / 30.1		
SCFF-39	4-24x56 FDE FFP								840 / 29.6		
SCFF-30		VCT-34FFP							810 / 26.6		
SCFF-41	5-30x56 FFP	VEC-MBR			8.2-1.4 24.5-4.1	26MIL(E) 16MIL(W)		392 / 15.4	810 / 26.6		
NEW SCFF-70	6-36x56 FFP	VCO-B MIL	6 levels R		7.0-1.2 21.0-3.6	31.5MIL(E) 20MIL(W)		430 / 16.9	861 / 30.4		15yds to ∞























The Vector Optics Continental 1-10x28 ED is an optic.

I personally use in DMR and ITPRA competitions, mounted on a semi-auto AR15 platform. Its versatility is perfect for these disciplines, where quick adjustments and clear vision are essential.

The 34mm tube provides excellent brightness and a wide field of view, ideal for precision shooting at varying distances. The illuminated tree reticle, with clear references for each click, allows for precise adjustments, supporting me in any shooting scenario. This optic is perfect for anyone seeking reliability and high level performance.

FEATURES

-  High Precision Adjustment
-  7075-T6 Aluminum Housing
-  Safari Hunting
-  VePRO™ FMC
-  LaREE HD Glass
-  3-Gun Competition
-  93% Light Transmission
-  Extra Large Eye Box (LPVO)
-  Dangerous Game Hunting
-  Zero Stop
-  Turret Lock
-  Law Enforcement
-  Set Zero Position
-  Scope Revolution Indicator
-  Lens Cover
-  IP67 Water Proof
-  Shock Proof Built to Endure
-  Tube Sunshade
-  Edge-to-Edge Clarity
-  With Rings

RETICLE PATTERN

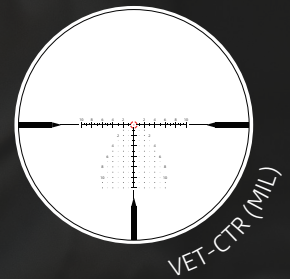

KJ Swagger
Italy



Power ring throw lever (SCCON-TL)



Parallax big side wheel genll (SCCON-SW2)



Metal flip-up cap

CONTINENTAL® 34MM ED

It delivers unmatched optical clarity with chromatic aberration-free ED glass, offering high magnification versatility. Each model features a Zero Stop and a revolution counter system for precise adjustments.

Clarity, Precision, Versatility.

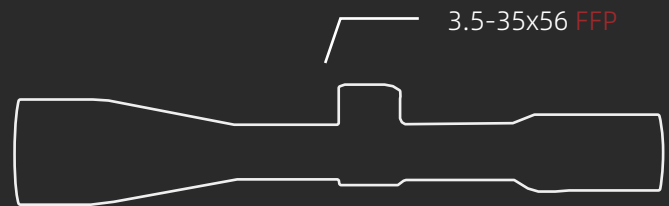

SKU	NAME	RETICLE	ILLUMINATION	EYE RELIEF (mm / in)	F.O.V (m @100 Meters) (ft @100 Yds)	ADJUSTMENT RANGE	TUBE SIZE	LENGTH (mm / in)	WEIGHT (net)(g / oz)	CLICK VALUE	PARALLAX ADJUSTMENT
SCFF-47	1-10x28 CTR FFP	VET-CTR			41-4.1 123-12.3	45MIL(E) 20MIL(W)					
New SCFF-62	1-10x28 RAR FFP	VET-RAR	11 levels R	100 / 4.0	35-3.5 105-10.5	30MIL	34mm	278 / 10.9	651 / 23.0	1/10MIL	100yds
New SCFF-68	1-10x28 RAR FDE FFP				34-4.0 102-12.0						

16 / CONTINENTAL



I am happy to report the Continental scope performed perfectly on this elk hunt. I shot a bull Elk at 300 yards. The scope was great. During the hunt, it also retained a perfect zero, it was bright & clear. The eye relief shooting the 375 Ruger was just fine.

Gordon Marsh
The U.S.A

FEATURES



High Precision Adjustment



7075-T6 Aluminum Housing



VePRO™ FMC



LaREE HD Glass



Light Transmission



Extra Large Eye Box (LPVO)



Set Zero Position



Water Proof



Shock Proof
Built to Endure



Edge-to-Edge Clarity



With Rings



Lens Cover



Tube Sunshade



Big Game Hunting



Mountain Hunting



Safari Hunting



Dangerous Game Hunting

RETICLE PATTERNS



German #4 Glass



VET-10BDC (MOA)



German #4 Fiber



Power ring throw lever (SCCON-TL)



Parallax big side wheel genll (SCCON-SW2)



Hunting ballistic turret (SCCON-HBT)



Metal flip-up cap

CONTINENTAL® HUNTING HD

Center dot illuminated reticle ideal for various hunting, such as: varmint, safari, big game and even dangerous game.

Simple, Reliable, And Easy To Use.



SKU	NAME	RETICLE	ILLUMINATION	EYE RELIEF (mm / in)	F.O.V (m @100 Meters) (ft @100 Yds)	ADJUSTMENT RANGE	TUBE SIZE	LENGTH (mm / in)	WEIGHT (net)(g / oz)	CLICK VALUE	PARALLAX ADJUSTMENT
SCOC-23	1-6x24 SFP	German #4 Glass			42.0-7.0 124.5-20.7	140MOA					
SCOC-46	1-6x24 FDE SFP							283 / 11.1	480 / 16.9	1/2MOA	
New SCOC-48	1-6x24 SFP	German #4 Fiber			36.4-6.8 109.1-20.4	120MOA					100yds
SCOM-23	1.5-9x42 SFP	German #4 Glass			28.0-4.7 84.0-14.0	140MOA	30mm		580 / 20.5		
SCOM-15	2-12x50 SFP	VET-10BDC	6 levels R	100 / 4.0	21.0-3.5 63.0-10.5			335 / 13.1	605 / 21.4		
SCOM-38	2.5-15x56 SFP	German #4 Glass			16.6-2.8 49.8-8.3	110MOA		370 / 14.6	670 / 23.6	1/4MOA	
SCOM-47	2.5-15x56 SFP	German #4 Fiber									10yds to ∞
New SCOL-65	3-18x50 SFP				13.8-2.3 41.5-6.9	75MOA		337 / 13.3	654 / 25.7		



Having used Vector Optics for my hunting and precision shooting needs over the past 3 years. I was beyond excited to get my hands on their latest offering, the Continental 8x 4-32x56 second focal plane hunting scope.

The 30mm monotube, capped 1/4MOA adjustments, and over 70 MOA adjustment range made it incredibly versatile for all of my hunting trips.

Furthermore, the lifetime warranty serves as a testament to Vector Optics' commitment to producing a top-tier, long-lasting scope that you can rely on for a lifetime.

Brett Eagle
South Africa

FEATURES



High Precision Adjustment



7075-T6 Aluminum Housing



VePRO™ FMC



LaREE HD Glass



Light Transmission



ED Glass



Extra Large Eye Box (LPVO)



Set Zero Position



Water Proof



Shock Proof
Built to Endure



Edge-to-Edge Clarity



With Rings



Lens Cover



Tube Sunshade



Dangerous Game Hunting



Mountain Hunting



Safari Hunting



Big Game Hunting

RETICLE PATTERNS



German #4 Glass



VET-10BDC (MOA)

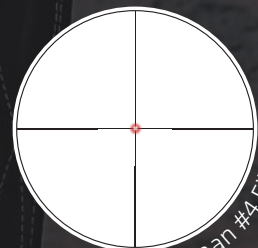

German #4 Fiber



Power ring throw lever (SCCON-TL)



Parallax big side wheel genll (SCCON-SW2)



Hunting ballistic turret (SCCON-HBT)



Metal flip-up cap

CONTINENTAL® HUNTING ED

The center dot illuminated reticle is ideal for various types of hunting, including varmint, safari, big game, and even dangerous game. Additionally, it features ED glass for improved clarity and performance.

Simple, Reliable, And Easy To Use.

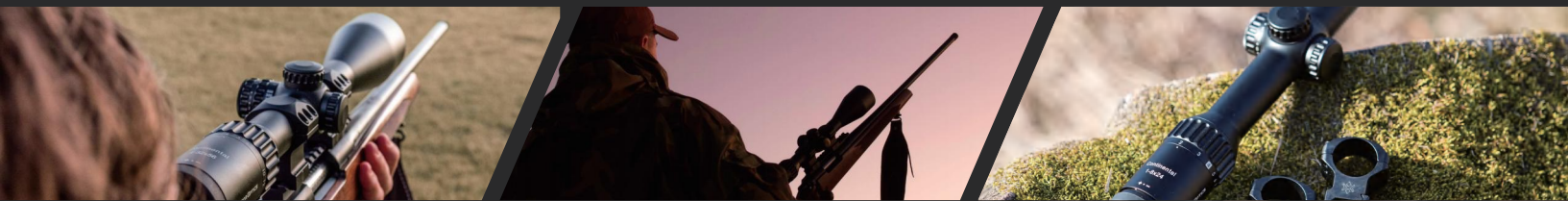



















SKU	NAME	RETICLE	ILLUMINATION	EYE RELIEF (mm / in)	F.O.V. (m @100 Meters) (ft @100 Yds)	ADJUSTMENT RANGE	TUBE SIZE	LENGTH (mm / in)	WEIGHT (net)(g / oz)	CLICK VALUE	PARALLAX ADJUSTMENT
SCOC-37	1-8x24 SFP	German #4 Glass			41.0-5.1 123-15.4	140MOA			493 / 17.4		
New SCOC-51	1-8x24 SFP	German #4 Fiber	11 levels	100 / 4.0	38.0-4.6 114-13.8	280MOA	30mm	284 / 11.2	504 / 17.8	1/2MOA	100yds
SCOM-45	2-16x50 SFP	VET-10BDC			20.5-2.6 61.5-7.7	110MOA		345 / 13.6	611 / 21.6		
New SCOL-64	3-24x56 SFP	German #4 Fiber			13.7-1.7 41.0-5.1	80MOA		376 / 14.8	736 / 26.0	1/4MOA	20yds to ∞



From the very first days, my Continental 5-30 became a faithful assistant in long-range shots. I tested the reliability of the sight on myself and my large caliber (300 win mag). The clarity of clicks and the accuracy of the mechanisms for entering amendments are at the highest level! The picture quality provided by excellent glass surprised even experienced high precision athletes. High-precision reticles allow quick adjustments without needing tactical drum rotation. Five shooters in our company already have similar devices from Vector Optics.

Alexey Oboishev

FEATURES

-  High Precision Adjustment
-  7075-T6 Aluminum Housing
-  3-Gun Competition (LPVO)
-  VePRO™ FMC
-  LaREE HD Glass
-  Target Long Range (In addition to 1-6x)
-  Light Transmission
-  Extra Large Eye Box (LPVO)
-  With Rings
-  Zero Stop (If Applicable)
-  Turret Lock
-  Tube Sunshade
-  Set Zero Position
-  Scope Revolution Indicator
-  Lens Cover
-  Shock Proof Built to Endure
-  Edge-to-Edge Clarity
-  Water Proof IP67

RETICLE PATTERNS



Power ring throw lever (SCCON-TL)



Parallax big side wheel genll (SCCON-SW2)



Metal flip-up cap (SCFC-M28, 50.56)

CONTINENTAL[®] TACTICAL HD

It covers not only compact and lightweight LPVO but also scope with Christmas tree style reticle identifies and engages target at substantial distance.

Compete, Protect, Defend.



SKU	NAME	RETICLE	ILLUMINATION	EYE RELIEF (mm / in)	F.O.V (m @100 Meters) (ft @100 Yds)	ADJUSTMENT RANGE	TUBE SIZE	LENGTH (mm / in)	WEIGHT (net)(g / oz)	CLICK VALUE	PARALLAX ADJUSTMENT
SCOC-23T	1-6x24 SFP	VET-BTR			42-7.0 124.5-20.7	45MIL		283 / 11.1	480 / 16.9		100yds
SCOC-34	1-6x24 FDE SFP	VET-FDR				40MIL					
SCOC-44	1-6x24 SFP	VET-FDR									
SCOL-53	3-18x50 ARI SFP	VCT-10A	6 levels	100 / 4.0	13.8-2.3 41.5-6.9	21.5MIL	30mm	337 / 13.3	580 / 20.5	1/10MIL	10yds to ∞
SCOL-54	4-24x50 ARI SFP				10.4-1.7 31.1-5.2	20MIL		370 / 14.6	605 / 21.4		
SCOL-43	4-24x50 FDE SFP	VCT-20A									15yds to ∞
SCOL-47	5-30x56 ARI SFP				8.3-1.4 24.9-4.2	16.5MIL		400 / 15.7	630 / 22.2		





















FEATURES

The Vector Continental ED Tactical Series Rifle Scopes are simply one of the best values in the scope market. They offer edge to edge clarity throughout their magnification ranges and have a very forgiving eye box that allows the shooter to quickly acquire his or her target fast.

I highly recommend the Vector Continental scope line and have confidence you will be pleased with the quality and features. I have been extremely impressed with the quality and reliability of these scopes.

Rodney Davis
The U.S.A

-  High Precision Adjustment
-  7075-T6 Aluminum Housing
-  3-Gun Competition (LPVO)
-  VePRO™ FMC
-  LaREE HD Glass
-  Target Long Range (6-48x)
-  90° Light Transmission
-  Extra Large Eye Box (LPVO)
-  With Rings
-  Zero Stop (If Applicable)
-  Turret Lock
-  Tube Sunshade
-  Set Zero Position
-  Scope Revolution Indicator
-  Lens Cover
-  1000G Shock Proof Built to Endure
-  Edge-to-Edge Clarity
-  IP67 Water Proof

RETICLE PATTERNS

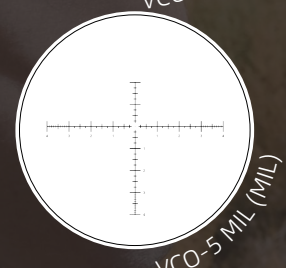
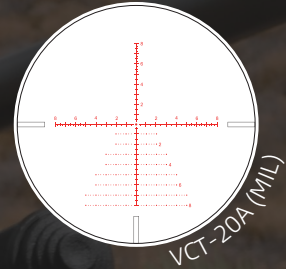

Power ring throw lever (SCCON-TL)



Parallax big side wheel genl (SCCON-SW2)



Metal flip-up cap

CONTINENTAL® TACTICAL ED

It covers not only compact and lightweight LPVO scopes, but also scopes with Christmastree-style reticles, with ED glass and up to 48x magnification. This allows for target identification and engagement at substantial distances.

Compete, Protect, Defend.

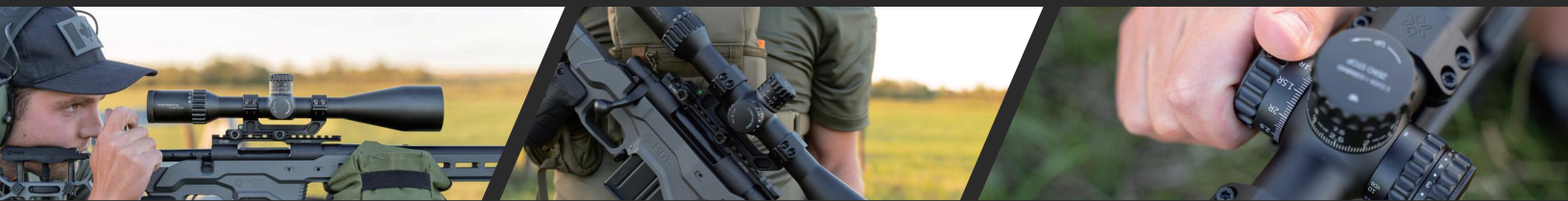

SKU	NAME	RETICLE	ILLUMINATION	EYE RELIEF (mm / in)	F.O.V (m @100 Meters) (ft @100 Yds)	ADJUSTMENT RANGE	TUBE SIZE	LENGTH (mm / in)	WEIGHT (net)(g / oz)	CLICK VALUE	PARALLAX ADJUSTMENT
SCOC-T37	1-8x24 SFP	VET-BTR			41.0-5.1 123-15.4	40MIL		284 / 11.2	523 / 18.4		
SCOC-45	1-8x24 SFP	VET-FDR						290 / 11.4	530 / 18.7		100yds
New SCOC-47	1-10x24 SFP	VCO-7 MIL			29.9-5.1 89.7-15.3	35MIL		280 / 11.0	519 / 18.3		
SCOM-T39	2-16x44 SFP	VTC-10A			20.5-2.6 61.5-7.7	32MIL		345 / 13.6	611 / 21.6	1/10MIL	
SCOL-T50	3-24x56 SFP		T1 Levels ¹	100 / 4.0	13.7-1.7 41-5.1	23MIL	30mm	376 / 14.8	836 / 29.5		
SCOL-T51	4-32x56 SFP	VCT-20A			10.3-1.3 30.8-3.8	20MIL		386 / 15.2	832 / 29.4		20yds to ∞
New SCOL-TE52	6-48x56 MOA SFP	VCO-6 MOA				48MOA				1/8MOA	
New SCOL-TM52	6-48x56 MIL SFP	VCO-5 MIL			6.8-0.9 20.5-2.6	14MIL		403 / 15.9	807 / 28.5	1/10MIL	

— PREMIUM LINE —



PREMIUM LINE

Lifetime Warranty



TAURON

PARAGON



Our Vector Optics premium lines, including TAURON, PARAGON, FRENZY, and SCRAPPER, offer exceptional clarity, superior quality, and a lifetime warranty. These well-crafted products provide an excellent shooting experience and long-lasting durability. Trust in our premium product line's quality and performance, backed by a lifetime warranty.



Clear vision & resolution, which indicates the quality of vector optics. Its weight, obedient clicks, FFP & SFP, all these, taking into account the pleasure of shooting. For which it deserves great approval and gratitude.

Levan Mosiashvili
Georgia

TOP OPTICS®

FEATURES



Fully Multi-coated



HD Glass
(if applicable)



Zero Stop
(if applicable)



Turret Lock



Set Zero Position



Water Proof



Shock Proof
Built to Endure



Edge-to-Edge Clarity



Target Long Range



With Rings



Lens Cover



Throw Lever
compatible



Law Enforcement



Mountain Hunting



Big Game Hunting



Varmint Hunting

RETICLE PATTERNS

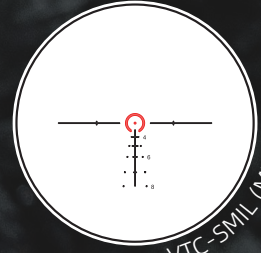

VTC-5MIL (MIL)



VTC-CMIL (MIL)

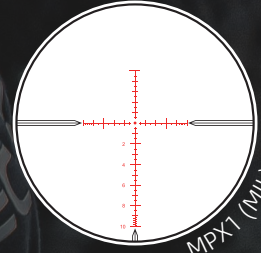

MPX1 (MIL)

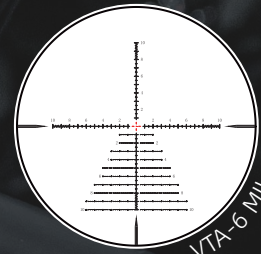

VTA-6 MIL

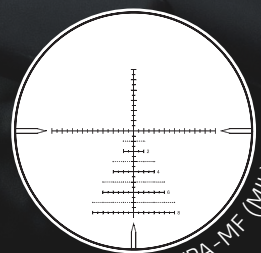

VPA-MF (MIL)



Parallax big side wheel genII
(SCCON-SW2)

TAURON 30MM

LPVO, medium & high power scope are engineered to deliver your CQB and long-range shooting with confidence at any magnification and distance.

Outstanding Clarity, Superior Quality.



SKU	NAME	RETICLE	ILLUMINATION	EYE RELIEF (mm / in)	F.O.V (m @100 Meters) (ft @100 Yds)	ADJUSTMENT RANGE	TUBE SIZE	LENGTH (mm / in)	WEIGHT (net)(g / oz)	CLICK VALUE	PARALLAX ADJUSTMENT
New SCFF-63	1-6x24 GenII FFP	VTC-CMIL			35.0-6.0 105.0-18.0	60MIL		264 / 10.4	537 / 18.9		100yds
New SCFF-64	3-18x50 GenII FFP				9.2-1.9 27.6-5.7	29MIL(E) 25MIL(W)		333 / 13.1	849 / 29.9		10yds to ∞
New SCFF-65	4-24x50 GenII FFP	MPX1			8.4-1.5 25.2-4.2	20MIL(E) 16MIL(W)		371 / 14.6	877 / 30.9		20yds to ∞
New SCFF-66	5-30x56 GenII FFP				6.8-1.2 20.4-3.6	17.5MIL(E) 16MIL(W)		395 / 15.5	924 / 32.6		20yds to ∞
New SCOC-49	1-6x24 GenII SFP	VTC-5MIL	6 levels R	100 / 4.0	35.0-6.0 105.0-18.0	60MIL	30mm	264 / 10.4	537 / 18.9	1/10MIL	100yds
SCOM-43	2-16x50 HD SFP	VTA-6 MIL			20.6-2.7 61.7-7.7	30MIL(E) 18MIL(W)		337 / 13.3	766 / 27.0		10yds to ∞
SCOL-45	4-16x44 HD SFP				8.7-2.2 26.2-6.6	24MIL		355 / 14.0	730 / 25.7		20yds to ∞
SCOL-46	6-24x50 HD SFP	MPX1			6.0-1.5 17.9-4.5	19.5MIL		360 / 14.2	763 / 26.9		10yds to ∞

PREMIUM





















The Tauron Premium line 34MM are high quality and robust rifle scopes without pointless extras. The design is clearly designed for function and makes the Tauron line the perfect all-rounder. The large selection from LPVO to high magnification long range scopes and the great adjustment options make the Tauron line suitable for sport shooting and hunters.

The Tauron line has been with me for a long time now, whether it's a match or training, and it has always impressed me again and again especially the good quality for the low price is something you can't get from any other company.

Marco Geiger
Germany

FEATURES

-  High Precision Adjustment
-  Fully Multi-coated
-  ED Glass (if applicable)
-  HD Glass (if applicable)
-  Zero Stop
-  Turret Lock
-  Set Zero Position
-  Water Proof
-  Shock Proof
Built to Endure
-  Edge-to-Edge Clarity
-  Target Long Range
-  With Rings
-  Lens Cover
-  Throw Lever Compatible
-  Dangerous Game Hunting
-  Mountain Hunting
-  Safari Hunting
-  Law Enforcement
-  Varmint Hunting

RETICLE PATTERNS

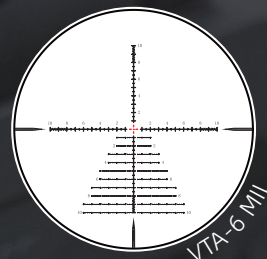
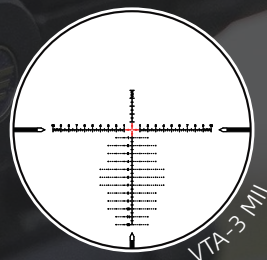

Parallax big side wheel genll
(SCCON-SW2)

TAURON 34MM HD & ED

LPVO, medium & high power optics integrate renowned HD & ED optics system with wide angle and long eye relief provides sharp images at any magnification.

Crystal, Classic, Competitive.

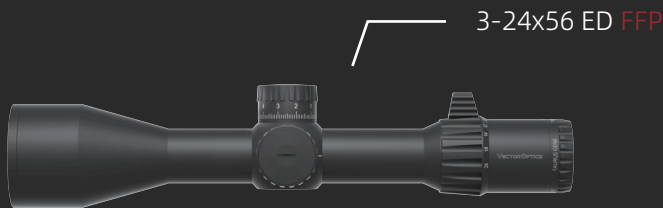

SKU	NAME	RETICLE	ILLUMINATION	EYE RELIEF (mm / in)	F.O.V (m @100 Meters) (ft @100 Yds)	ADJUSTMENT RANGE	TUBE SIZE	LENGTH (mm / in)	WEIGHT (net)(g / oz)	CLICK VALUE	PARALLAX ADJUSTMENT
SCFF-33	3-24x56 ED FFP	VTA-5 MIL	N/A		13.7-1.7 41.0- 5.13	30MIL(E) 20MIL(W)		347 / 13.7	1007 / 35.5		10yds to ∞
SCFF-34	4-32x56 ED FFP				10.3-1.3 30.8-3.85	28MIL(E) 16MIL(W)		360 / 14.2	1007 / 35.5	1/10MIL	25yds to ∞
New SCFF-35	5-40x56 ED FFP	VTA-8 MIL			8.0-1.1 24.0-3.0	28MIL(E) 16MIL(W)		366 / 14.4	978 / 34.5		
SCFF-45	4-16x44 MIL HD FFP	VTA-3 MIL			10.5-2.6 31.4-7.85	33MIL(E) 15MIL(W)		318 / 12.5	903 / 31.8		15yds to ∞
SCFF-50	4-16x44 MOA HD FFP	VTA-4 MOA		100 / 4.0		110MOA(E) 50MOA(W)	34mm			1/4MOA	
SCFF-46	6-24x50 MIL HD FFP	VTA-3 MIL	6 levels R		7.0-1.7 20.9-5.2	23MIL(E) 15MIL(W)		353 / 13.9	974 / 34.3	1/10MIL	10yds to ∞
SCFF-51	6-24x50 MOA HD FFP	VTA-4 MOA				80MOA(E) 36MOA(W)				1/4MOA	
SCOL-55	3-24x56 ED SFP	VTA-7 MIL			13.7-1.7 41.0-5.1	30MIL(E) 20MIL(W)		347 / 13.7	991 / 34.9	1/10MIL	15yds to ∞
SCOL-56	4-32x56 ED SFP	VTA-6 MIL			10.3-1.3 30.8-3.85	28MIL(E) 16MIL(W)		360 / 14.2	1004 / 35.4		25yds to ∞

PREMIUM

/ PARAGON PRISM SCOPE



I have fallen in love with the Vector Optics Paragon series magnifiers and prism scopes in the past year, these work well with my shooting sports.

I use the Paragon 4x Micro paired with a red dot scope on my main competition gun. Key features why I chose the paragon prism scope over others are that the mount is very stable with zero wobbles in either use or swung to the side and the optic clarity is excellent, a key feature in fast-paced shooting where it's vital to identify the target fast and engage it equally fast.

Jani Nordman
Finland

FEATURES



Fully Multi-coated



Shock Proof
Built to Endure



Water Proof



Nitrogen Purged



Light Weight



3-Gun Competition



CQB Environment

RETICLE PATTERNS



VEP-CDR (MOA)

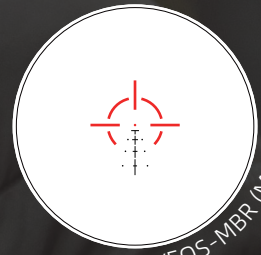

VE05-MBR (MOA)



RUM cantilever picatinny riser mount (SCPSM-01)



Red dot sight offset mount MAG (SCPSM-C01)



RUM low profile picatinny mount (SCPSM-02)



RUM high cantilever picatinny riser mount (SCPSM-03)



Honeycomb Sunshade

PARAGON PRISM SCOPE

It covers not only magnifiers but scope with wide angle and true long eye relief. Adjustable diopter ensures crisp clear reticle image. Offer variable center height mounting options.

Small Size But It Tells Big.



SKU	NAME	RETICLE	ILLUMINATION	EYE RELIEF (mm / in)	F.O.V (m @100 Meters) (ft @100 Yds)	ADJUSTMENT RANGE	CENTER HEIGHT (mm / inch)	LENGTH (mm / in)	WEIGHT (net)(g / oz)	CLICK VALUE	PARALLAX ADJUSTMENT
SCPS-M01	1x16	VEP-CDR		76 / 3.0	25.4 76.3			75 / 3.0	225 / 7.9		
SCPS-M03	3x18	VEPS-MBR	10 levels	68 / 2.7	12.9 38.8	100MOA	36 / 1.4	77 / 3.1		1MOA	
SCPS-M04	4x24				9.6 28.8			81 / 3.2	250 / 9.8		100yds
New SCPS-M10	1x18 X-MINI	VEP-CDR	10 levels R & G	95 / 3.7	26.3 78.9			60 / 2.4	178 / 6.3		

PREMIUM

— CLASSIC LINE —



CLASSIC LINE

5-year Warranty



CONSTANTINE

ORION

VEYRON

MINOTAUR

HUGO

MATIZ



Our classic product line is the ideal choice for those looking for a reliable option that offers a balance of performance and affordability. These products come with a reassuring 5-year warranty, providing peace of mind throughout your shooting adventures.



Sebastian Wickert
Germany

Vector Optics Constantine series is characterized by high reliability and an excellent price/performance ratio. The brightness and sharpness and optical performance of this riflescope are surprisingly good. The illuminated BDC reticle is up to all situations. Whether 25m or 300m, the Constantine is always a good companion and a very good riflescope in this price range.

FEATURES

- Fully Multi-coated
- 1x with Eyes Open
- Edge-to-Edge Clarity
- Set Zero Position
- Fiber Optics Illumination (if applicable)
- Shock Proof Built to Endure
- Throw Lever Compatible
- Nitrogen Purged
- With Rings
- Flip-up Cap
- CQB Environment
- Dangerous Game Hunting
- 3-Gun Competition
- Big Game Hunting

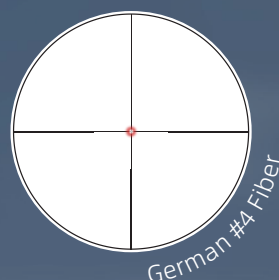

German #4 Fiber

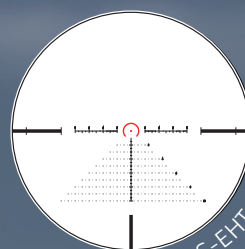

VOS-EHT (MIL)



VOF-EHT (MIL)

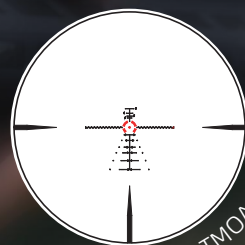

VOS-TMOA (MOA)

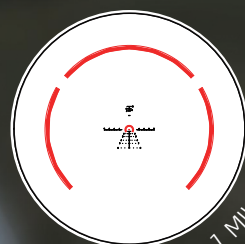

VCO-1 MIL (MIL)

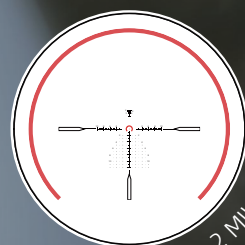

VCO-2 MIL (MIL)

CONSTANTINE

Starts at a true 1x power, which is specific for your recon rifle optic.
Fiber or etched glass reticle with better eye relief and eye-box range for fast acquisition.

Simple, Versatile, Effective.



SKU	NAME	RETICLE	ILLUMINATION	EYE RELIEF (mm / in)	F.O.V (m @100 Meters) (ft @100 Yds)	ADJUSTMENT RANGE	TUBE SIZE	LENGTH (mm / in)	WEIGHT (net)(g / oz)	CLICK VALUE	PARALLAX ADJUSTMENT
SCOC-36	1-6x24 SFP	German #4 Fiber			38.75-6.4 116.2-19.2	120MOA		264 / 10.4	530 / 18.6	1/2MOA	
SCOC-27	1-8x24 SFP	VOS-EHT		100 / 4.0	41.9-4.9 125.6-14.8			263 / 10.3			
SCFF-32	1-8x24 CTR FFP	VOF-EHT			38.9-4.9 116.6-14.8	35MIL		273 / 10.7	500 / 17.3	1/10MIL	
SCFF-60	1-8x24 RAR FFP	VCO-1 MIL	11 Levels R	95 / 3.7			30mm				100yds
SCOC-31	1-10x24 SFP	VOS-TMOA		95-90 / 37-3.5		120MOA		280 / 11.0	530 / 18.6	1/2MOA	
SCOC-35	1-10x24 SFP	VECNS-G4F		90 / 3.5	38.0-3.8 113.9-11.5			268 / 10.5	540 / 19.0		
New SCFF-42	1-10x24 HD FFP	VCO-2 MIL		100 / 4.0		35MIL		251 / 9.9	565 / 19.9	1/10MIL	

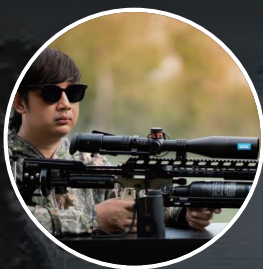

Randy Wiranata
Indonesia

If you want smooth hunting, borrow one hundred first, the Orion series gives you what you want, save your hunting moment.

FEATURES



Fully Multi-coated



LaREE HD Glass



Target Long Range



Zero Stop



Turret Lock



Set Zero Position



Shock Proof
Built to Endure



Edge-to-Edge Clarity



Side Parallax
Correction



With Rings



Flip-up Cap



Tube Sunshade



Small Game Hunting



Varmint Hunting



Big Game Hunting



Scope universal big side wheel
(SCBSW-U1)

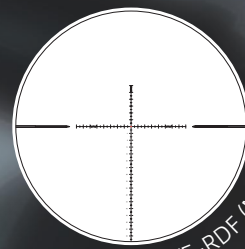

VE-RDF (MOA)

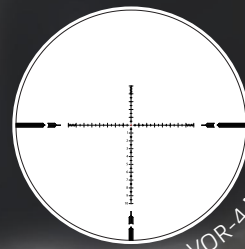

VOR-4 MIL

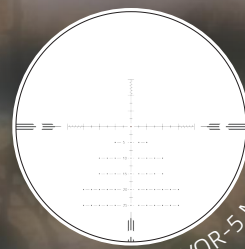

VOR-5 MOA



VOR-6 MIL



VOR-7 MIL

ORION

Designed with fully multi-coated, reduced-glare lenses that deliver edge-sharp image clarity. Purpose-built reticle creates optimal target engagement in a wide range of scenarios. Precise adjustment with turret lock & zero-reset.

Clear Image, Clear Choice.



SKU	NAME	RETICLE	ILLUMINATION	EYE RELIEF (mm / in)	F.O.V (m @100 Meters) (ft @100 Yds)	ADJUSTMENT RANGE	TUBE SIZE	LENGTH (mm / in)	WEIGHT (net)(g / oz)	CLICK VALUE	PARALLAX ADJUSTMENT
SCFF-49	3-18x44 HD FFP	VOR-4 MIL		96-95 / 3.8-3.7	12.7-2.1	100MOA(E) 60MOA(W)	30mm	343 / 13.5	798 / 28.1	1/10MIL	
SCOL-57	3-18x50 HD SFP	VOR-5 MOA			38.2-6.3					825 / 29.1	1/4MOA
SCOL-62	4-16x44 HD SFP	VOR-7 MIL		95 / 3.7	9.6-2.3	30MIL(E) 20MIL(W)	30mm	353 / 13.9	753 / 26.6		
SCFF-59	4-16x44 HD FFP	VOR-4 MIL	6 levels R		28.8-6.8	32MIL(E) 18MIL(W)			756 / 26.7	1/10MIL	10yds to ∞
SCOL-63	6-24x50 HD SFP	VOR-6 MIL				23MIL(E) 18MIL(W)		353 / 13.9	790 / 27.9		
SCFF-44	6-24x50 MOA FFP	VE-RDF		85-80 / 3.5-3.1	6.3-1.6	90MOA(E) 60MOA(W)		340 / 13.4	782 / 27.6	1/4MOA	
SCFF-61	6-24x50 MIL HD FFP	VOR-4 MIL		95 / 3.7	18.9-4.7	23MIL(E) 18MIL(W)		343 / 13.5	756 / 26.7	1/10MIL	



Michał Mierkowski
Poland

The Veyron stands out from other models due to its compact size, low weight, and ability to maintain high image quality. Despite its small size, this scope offers up to x24 magnification, making it perfect for small, light rifles. It provides a clean and transparent image, distinguishing it from scopes offered by other companies.



MPR-V5 (MIL)

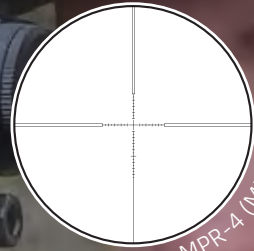













MPR-4 (MIL)



MPR-V10 (MIL)

FEATURES

-  Extra Short Size
-  Fully Multi-coated
-  Turret Lock
-  Set Zero Position
-  Shock Proof
Built to Endure
-  Nitrogen Purged
-  Side Parallax Correction
-  With Rings
-  Honeycomb Sunshade
-  Flip-up Cap
-  Small Game Hunting
-  Varmint Hunting



Scope universal big side wheel (SCBSW-U1)



Scope Power Ring Lever (SCOT-57FF)

VEYRON

It features low, medium & high-power editions with 1/10MIL turret-lock adjustment, which are especially designed for light weight firearms, PCP, springer and gasram recoiling air rifles.

Ideal For Your Hunting And General Shooting.



SKU	NAME	RETICLE	ILLUMINATION	EYE RELIEF (mm / in)	F.O.V (m @100 Meters) (ft @100 Yds)	ADJUSTMENT RANGE	TUBE SIZE	LENGTH (mm / in)	WEIGHT (net)(g / oz)	CLICK VALUE	PARALLAX ADJUSTMENT
SCOC-43	2-8x32IR SFP	MPR-V5	6 levels R		17.4-4.35 52.4-13.1	23MIL		220 / 8.7	425 / 15.0		100yds
New SCOM-46	10x30 ZERO SFP	MPR-V10	11 levels R		9.4 28.3	26MIL		212 / 8.4	420 / 14.8		6yds to ∞
SCOM-41	10x44 SFP	MPR-V5	N/A		3.5 10.5	17.5MIL		245 / 9.7	500 / 17.6		
SCOM-40	3-12x44IR SFP	MPR-V10	6 levels R	90-85 / 3.5-3.4	11.7-2.9 35.1-8.7		30mm	245 / 9.7	515 / 20.3	1/10MIL	
SCOL-48	4-16x44IR SFP				8.7-2.2 26.2-6.55	17.5MIL		270 / 10.6	545 / 21.5 530 / 18.7		10yds to ∞
SCFF-38	4-16x44IR FFP	MPR-V5									
SCOL-49	6-24x44IR SFP	MPR-V10	6 levels R		5.8-1.45 17.5-4.3			275 / 10.8	595 / 23.4		
SCFF-37	6-24x44IR FFP	MPR-V5							580 / 20.5		

40 / MINOTAUR



Tomasz Kocemba
Poland

It's fairly large with the 60mm objective and 34mm tube, but not overly large like some other scopes offering such great magnification.

The image is bright and the optical quality is surprisingly good for the price.

It introduces the shooter to a new world of x60 magnification.

Fine reticle, with illuminated, well-calibrated central dot allows you to aim with accuracy like never before. The reticle markings for holdover or windage designed to keep that sight picture as clean and uncluttered as possible, and are good for most long-distance shots.

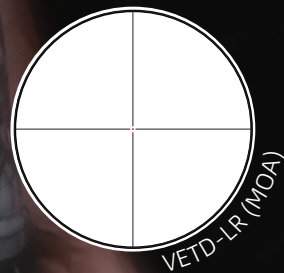

VETD-LR (MOA)

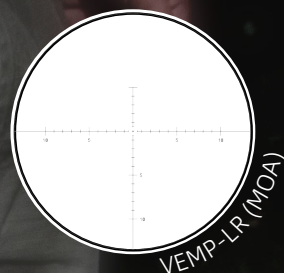

VEMP-LR (MOA)

FEATURES



Fully Multi-coated



Target Long Range



Zero Stop



Turret Lock



Set Zero Position



Digital Control



Nitrogen Purged



Side Parallax Correction



Audible mechanical clicks



Shock Proof
Built to Endure



With Rings



Flip-up Cap



Tube Sunshade



Benchrest Shooting



Scope universal big side wheel (SCBSW-U1)

MINOTAUR

Purpose-built for the competitive shooter. Center dot illuminated reticle with 1/8MOA zero stop adjustment for your precision bench rest at long range and accurate competition.

It's A Loyal Partner For Your Competition Shooting.



SKU	MAGNIFICATION OBJECTIVE LENS DIAMETER	RETICLE	ILLUMINATION	EYE RELIEF (mm / in)	F.O.V. (m @100 Meters) (ft @100 Yds)	ADJUSTMENT RANGE	TUBE SIZE	LENGTH (mm / in)	WEIGHT (net)(g / oz)	CLICK VALUE	PARALLAX ADJUSTMENT
SCOL-36	10-50x60 DOT SFP	VETD-LR			3.7-0.7 11.0-2.2				960 / 33.9		
SCOL-39	10-50x60 MFL SFP	VEMP-LR									
SCOL-37	12-60x60 DOT SFP	VETD-LR	10 levels +1 NV	96-95 / 3.8-3.7	3.05-0.6 9.15-1.8	50MOA	34mm	425 / 16.7		1/8MOA	10yds to ∞
SCOL-40	12-60x60 MFL SFP	VEMP-LR									
SCOL-38	46x60 DOT SFP	VETD-LR			0.9 2.75				945 / 33.3		
SCOL-41	46x60 MFL SFP	VEMP-LR									



Karl Orange
England

Big on quality, small on price.



FEATURES



Fully Multi-coated



Turret Lock



Set Zero Position



Digital Control
(if applicable)



Shock Proof
Built to Endure



Nitrogen Purged



Side Parallax
Correction



With Rings



Flip-up Cap



Tube Sunshade



Small Game Hunting



Varmint Hunting



Scope universal big side wheel
(SCBSW-U1)

HUGO

Min focus from 10 yards scopes with wide field of view and 4in long eye relief. Premium fully multi coated lens delivers crisp and sharp image. It provides wire etched glass or fiber reticle with 1/4MOA turret lock adjustment.



Range It, Dial It And Aim Dead On.











SKU	NAME	RETICLE	ILLUMINATION	EYE RELIEF (mm / in)	F.O.V (m @100 Meters) (ft @100 Yds)	ADJUSTMENT RANGE	TUBE SIZE	LENGTH (mm / in)	WEIGHT (net)(g / oz)	CLICK VALUE	PARALLAX ADJUSTMENT
SCOM-30	3-12x44 SFP	VOW-10BDC	N/A		10.5-2.6 31.5-7.9	60MOA			588 / 20.7	1/4MOA	
SCOM-31	3-12x44 GT SFP	VOI-10BDC	10 levels +1 NV		8.7-2.8 26.0-8.4	26MIL		325 / 12.8	616 / 21.7		
SCOM-44	3-12x40 SFP	VHU-3 MIL							612 / 21.6	1/10MIL	
SCOL-29	4-16x44 SFP	VOW-10BDC	N/A	105-100 / 4.1-3.9	7.0-1.8 21.1-5.3		1" (25.4mm)	345 / 13.6	641 / 22.6		10yds to ∞
SCOL-30	4-16x44 GT SFP	VOI-10BDC	10 levels +1 NV			60MOA			650 / 22.9	1/4MOA	
SCOL-32	6-24x50 GT SFP				5.3-1.3 15.8-4.0			360 / 14.2	673 / 23.1		
SCOL-31	6-24x50 SFP	VOW-10BDC	N/A								



René Kristiansen
Denmark

The Matiz riflescope is a 1-inch scope with capped adjustment. It features an FMC optical system housed in a rugged, aircraft-grade aluminum 1-inch main tube. This scope offers a wide field of view at low power and enables detailed viewing at high power. It is particularly well-suited for rimfire platforms and is suitable for medium to long-range shooting. Moreover, it is user-friendly for shooters of all skill levels.

FEATURES

-  Fully Multi-coated
-  Set Zero Position
-  Shock Proof
Built to Endure
-  Edge-to-Edge Clarity
-  Hunting Style
-  With Rings
-  Lens Cover
-  Small Game Hunting
-  Varmint Hunting

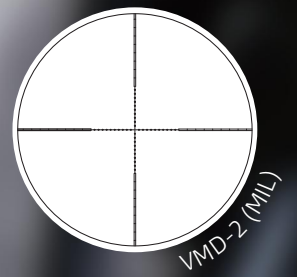

MATIZ

FMC optical system housed in a rugged and aircraft-grade aluminum 1in main tube. Provide the great field of view at low power and tell the detail at high power. Ideal for your rimfire platform from medium to long range shooting.

Easy To Use For Any Shooter.



2-7x32



6-18x44



SKU	NAME	RETICLE	ILLUMINATION	EYE RELIEF (mm / in)	F.O.V (m @100 Meters) (ft @100 Yds)	ADJUSTMENT RANGE	TUBE SIZE	LENGTH (mm / in)	WEIGHT (net)(g / oz)	CLICK VALUE	PARALLAX ADJUSTMENT
SCOM-26	2-7x32 SFP	Duplex		108-98 / 4.2-3.9	14.0-4.0 42.0-12.05			280 / 11.0	375 / 13.2		
SCOM-33	2-7x32 MOA SFP	VOW-MOA	N/A			60MOA				1/4MOA	
SCOM-27	3-9x40 MOA SFP	Duplex			11.5-3.8 34.55-11.5			305 / 12.0	405 / 14.3		100yds
SCOM-32	3-9x40 MIL SFP	VMD-2		105-96 / 4.1-3.8		17.5MIL	1" (25.4mm)		398 / 14.0	1/10MIL	
SCOM-28	3-9x50 SFP	German #4	11 levels		11.0-3.8 33.0-11.5			310 / 12.2	500 / 17.6		
SCOM-29	4-12x40 SFP	VOW-10BDC	N/A	108-98 / 4.2-3.9	7.9-2.4 23.6-7.3	60MOA		345 / 13.6	520 / 18.3	1/4MOA	
SCOL-28	6-18x44 SFP			102-96 / 4.0-3.9	4.4-1.9 13.1-5.75				542 / 19.1		10yds to ∞

— ENTRY LINE —



ENTRY LINE

5-year Warranty



SENTINEL

GRIZZLY

MUSTANG

FORESTER



Our entry-level product line is perfect for beginners and casual shooters who prioritize affordability without compromising on quality.

These products provide a great starting point and come with the added assurance of a generous 5-year warranty.



Rob Taylor
United Kingdom

I use the sentinel genll 10-40x50 on all my rifles. I have compared the sentinel genll to other manufacturers scopes costing 5 times more and every time the sentinel wins. A friend had a scope costing £2600, he compared it to my sentinel.

FEATURES



Fully Multi-coated



Target Long Range



Zero Stop
(If Applicable)



Turret Lock



Set Zero Position



Shock Proof
Built to Endure



Nitrogen Purged



Side Parallax
Correction



Edge-to-Edge Clarity



With Rings



Honeycomb
Sunshade



Flip-up Cap



Big Game Hunting



Scope universal big side wheel
(SCBSW-U1)



Scope Power Ring Lever
(SCOT-57FF)

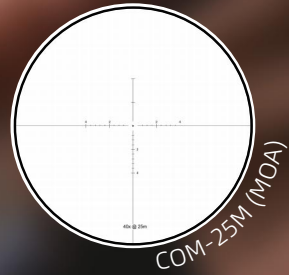

COM-25M (MOA)

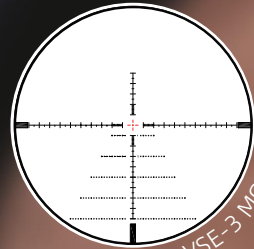

VSE-3 MOA

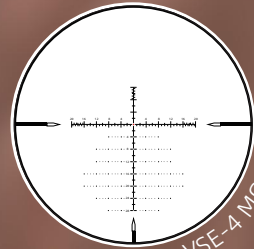

VSE-4 MOA

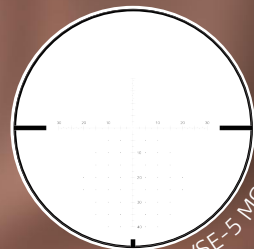

VSE-5 MOA

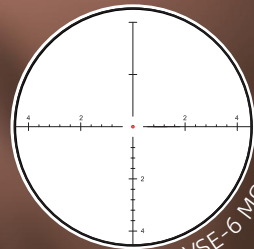

VSE-6 MOA

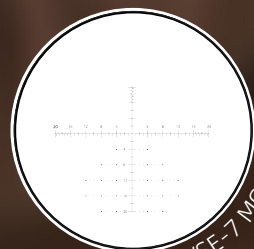

VSE-7 MOA

SENTINEL

It is engineered to deliver clear image for benchrest competition, PCP and general shooting. Affordable price with exposed MOA turret-lock or zero-stop adjustment. Parallax correction at side with illumination.

As Classic As It Is Versatile.



SKU	NAME	RETICLE	ILLUMINATION	EYE RELIEF (mm / in)	F.O.V (m @100 Meters) (ft @100 Yds)	ADJUSTMENT RANGE	TUBE SIZE	LENGTH (mm / in)	WEIGHT (net)(g / oz)	CLICK VALUE	PARALLAX ADJUSTMENT
SCOL-59	4-16x50 SFP	VSE-4 MOA		100 / 4.0	8.2-2.1 24.6-6.3	70MOA(E) 50MOA(W)		355 / 14.0	759 / 26.8		
SCOL-60	6-24x50 SFP	VSE-7 MOA	6 levels	105-100 4.1-3.9	6.1-1.5 18.3-4.6	50MOA(E) 40MOA(W)		369 / 14.5	792 / 27.9	1/4MOA	
SCOL-61	8-32x50 SFP	VSE-4 MOA				40MOA(E) 30MOA(W)		408 / 16.0	840 / 29.6		
SCOL-34	10-40x50 SFP	COM-25M	N/A			50MOA			775 / 27.3		
SCOL-58	10-40x50 SFP	VSE-6 MOA	11 levels	92-85 / 3.6-3.3	1.3-0.4 3.8-1.1	60MOA	30mm	405 / 15.9	792 / 27.9	1/8MOA	10yds to ∞
SCFF-56	4-16x44 FFP	VSE-3 MOA		100 / 4.0	8.2-2.1 24.6-6.3	70MOA(E) 50MOA(W)		368 / 14.5	775 / 27.3		
SCFF-57	6-24x50 FFP	VSE-3 MOA	6 levels		6.1-1.5 18.3-4.6	55MOA(E) 40MOA(W)			792 / 27.9	1/4MOA	
SCFF-58	5-25x50 HD FFP	VSE-5 MOA		95 / 3.7	7.7-1.5 23.0-4.6	80MOA(E) 60MOA(W)		356 / 14.0	792 / 27.9		

ENTRY



Legat Werner
Austria

The right scope for a young hunter on a small budget. It easily tolerates up to 30.06 and has crystal-clear and bright optics with a very unbleed red dot. I use it on an air rifle (45 joules) where even expensive brands can't withstand the recoil.

This is where the Grizzly shows its quality.



FEATURES



Fully Multi-coated



Set Zero Position



Fiber Optics
Illumination
(if applicable)



Shock Proof
Built to Endure



Water Proof
(6x)



With Rings



Edge-to-Edge Clarity



Lens Cover



Throw Lever
Compatible



Small Game Hunting



Turkey Hunting



Safari Hunting



Big Game Hunting

GRIZZLY

It's a classic scope, with decent image quality and reliable MOA adjustment. A variety of configurations rugged in a robust 30mm monotube. At this price, you can spend more time in the woods. Provide fiber reticle edition for the strongest sunlight condition.

Get More Than You Pay For.



1-6x24 HD



3-12x56



SKU	NAME	RETICLE	ILLUMINATION	EYE RELIEF (mm / in)	F.O.V (m @100 Meters) (ft @100 Yds)	ADJUSTMENT RANGE	TUBE SIZE	LENGTH (mm / in)	WEIGHT (net)(g / oz)	CLICK VALUE	PARALLAX ADJUSTMENT
SCOC-41	1-4x24 SFP	German #4 Glass	11 levels	105-100 / 4.1-3.9	35.3-8.7 105.8-26.2	120MOA		260 / 10.2	470 / 16.6	1/2MOA	100yds
SCOC-50	1-6x24 HD SFP	German #4 Fiber	6 levels	96-95 / 3.8-3.7	38.9-6.4 116.6-19.2	80MOA		268 / 10.6	500 / 17.6	1/10 MIL	
SCOM-48	2.5-15x50 HD SFP	German #4 Glass	6 levels	96-95 / 3.8-3.7	15.6-2.6 46.8-7.8	16MIL		338 / 13.3	670 / 23.6		10yds to ∞
SCOM-09	3-12x56 SFP	German #4 Glass	11 levels	105-100 / 4.1-3.9	12.2-3.1 36.7-9.2	70MOA	30mm	330 / 13.0	700 / 24.7	1/4 MOA	100yds
SCOM-49	3-12x56 HD SFP	German #4 Fiber	6 levels	97 / 3.8	13.8-3.5 41.5-10.4	70MOA		345 / 13.6	605 / 21.3		
SCOL-67	3-18x56 HD SFP	German #4 Glass	6 levels	96-95 / 3.8-3.7	12.7-2.1 38.2-6.3	50MOA		346 / 13.6	654 / 25.7	1/10 MIL	10yds to ∞



30mm 4x zoom LPVO SFP & FFP optics with one-piece picatinny mount, which is 100mm long eye relief & specifically designed for AR platform.

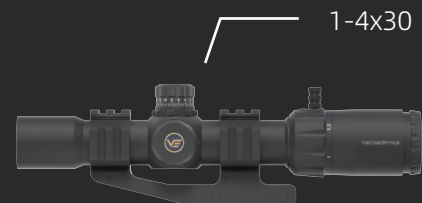

SKU	NAME	RETICLE	ILLUMINATION	EYE RELIEF (mm / in)	F.O.V (m @100 Meters) (ft @100 Yds)	ADJUSTMENT RANGE	TUBE SIZE	LENGTH (mm / in)	WEIGHT (net)(g / oz)	CLICK VALUE	PARALLAX ADJUSTMENT
SCOC-29	1-4x30 SFP	Chevron	R & G & B	105-100 / 4.1-3.9	35.3-8.7 105.8-26.2	100MOA	30mm	250 / 9.9	725 / 25.6	1/2MOA	100yds
SCFF-36	1-4x24 FFP	M-4RD	6 levels R					255 / 10.0	485 / 17.1		

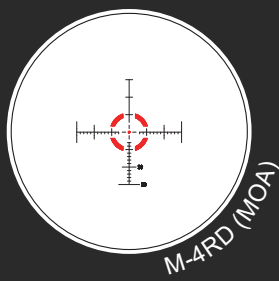

- Fully Multi-coated
- Set Zero Position
- Shock Proof
Built to Endure
- Edge-to-Edge Clarity
- Hunting style
- With Rings
- Lens Cover

FORESTER

It provides a wide selection of magnifications and characteristics with aggressive price level. Deliver long eye relief, wide field of view, large eye box and edge-to-edge image with MOA adjustment.

It's Just Your First Scope.

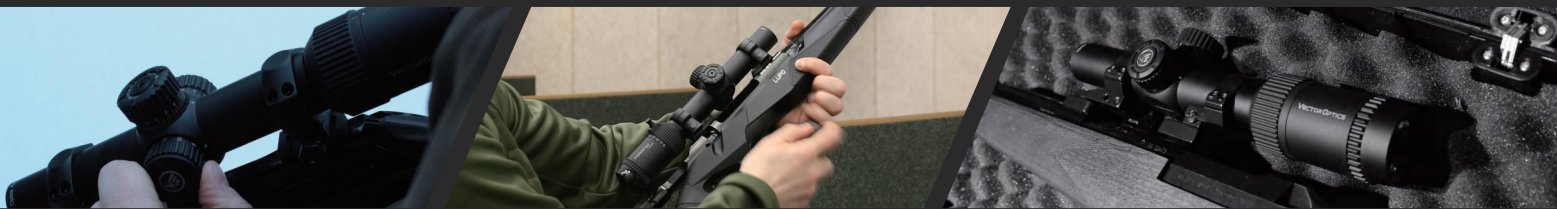
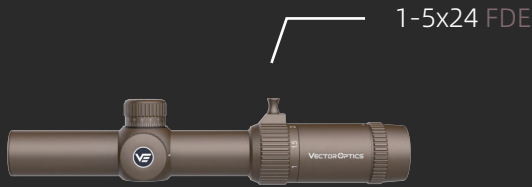

SKU	NAME	RETICLE	ILLUMINATION	EYE RELIEF (mm / in)	F.O.V (m @100 Meters) (ft @100 Yds)	ADJUSTMENT RANGE	TUBE SIZE	LENGTH (mm / in)	WEIGHT (net)(g / oz)	CLICK VALUE	PARALLAX ADJUSTMENT
SCOC-28	1-4x24 SFP	VFD-3	N/A	110-90 / 4.3-3.5	17.4-4.35 73.3-23.6	100MOA		260 / 10.2	390 / 13.8		
SCOC-03II	1-5x24 SFP			115-95 / 4.5-3.7	24.4-6.6 73.3-19.9			260 / 10.2	425 / 15.0		
SCOC-32	1-5x24 FDE SFP	VFD-2	11 levels			120MOA	30mm			1/2MOA	50yds
SCOC-38	1-8x24 SFP			85-75 / 3.3-3.0	35.0-6.3 105-18.9			262 / 10.3	580 / 20.5		
SCOC-39	1-8x24 FDE SFP										
SCOM-35	3-9x40 SFP	VFD-3	N/A	75-70 / 3.0-2.8	12.9-4.4 38.8-13.1	100MOA		295 / 11.6	430 / 15.2	1/4MOA	

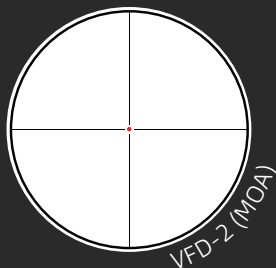
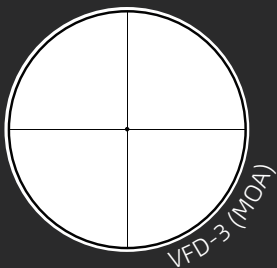

- Fully Multi-coated
- Set Zero Position
- Shock Proof Built to Endure
- Edge-to-Edge Clarity
- Throw Lever Compatible
- Small Game Hunting
- With Rings
- Lens Cover

ENTRY

— PREMIUM LINE —



PREMIUM LINE

Lifetime Warranty

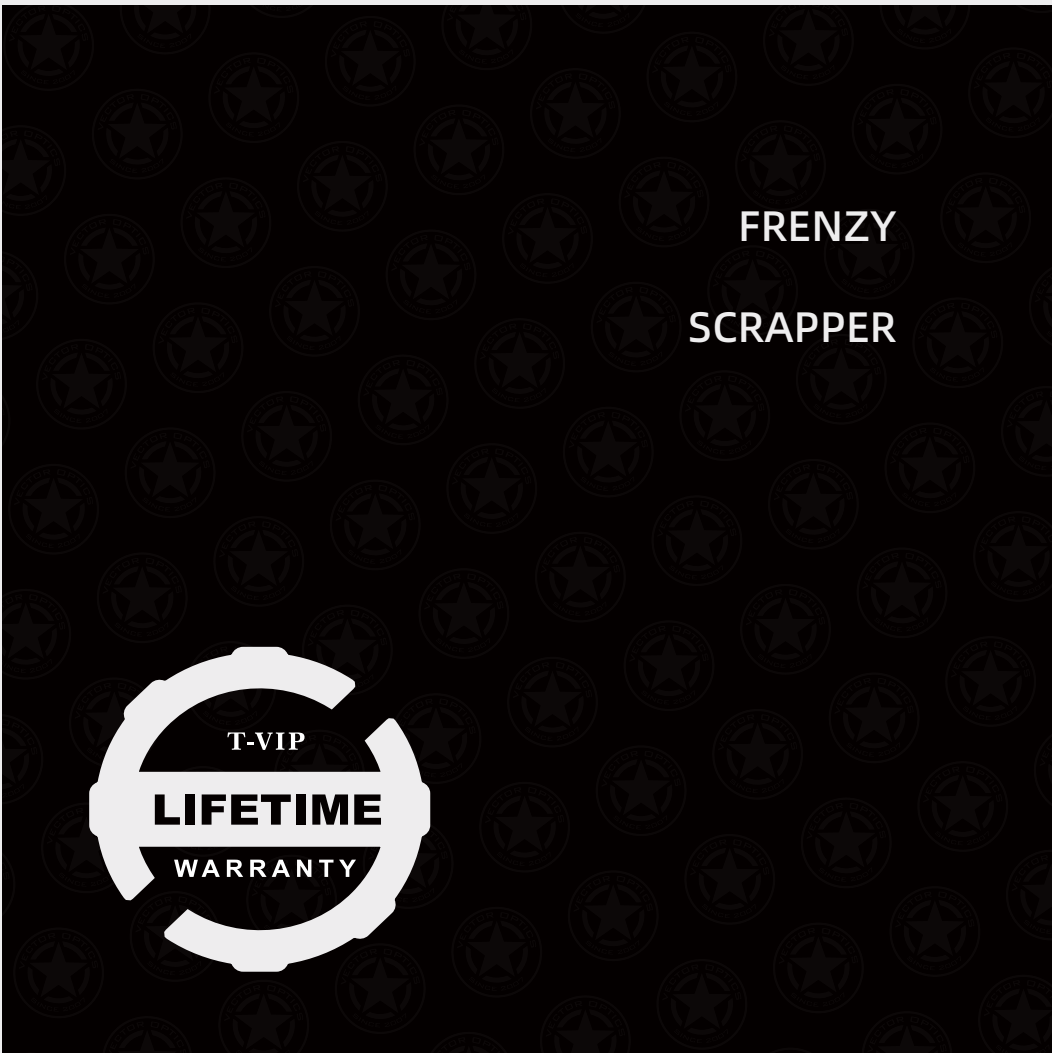

FRENZY
SCRAPPER



Our Vector Optics premium lines, including TAURON, PARAGON, FRENZY, and SCRAPPER, offer exceptional clarity, superior quality, and a lifetime warranty.

These well-crafted products provide an excellent shooting experience and long-lasting durability. Trust in our premium product line's quality and performance, backed by a lifetime warranty.

56 / FRENZY

FRENZY *New*

It's a genII pistol red dot sight, no weak sight.



1x17x20

SCRD-68

Aspheric Lens

1x17x20

SCRD-SM68

Aspheric Lens

Solar Panels

1x17x21

SCRD-73

Aspheric Lens

1x19x28

SCRD-66

3MOA

Multi-Reticle

3MOA

3MOA

Reticle

Black Matte

Black Matte

Black Matte

Black Matte

Finish

7075

7075

7075

7075

Housing
Material

N/A

N/A

N/A

N/A

Auto Light
Sensor

Yes

Yes

N/A

Yes

Motion
Sensor

40.8 / 1.6

40.8 / 1.6

41 / 1.6

40 / 1.6

Length
(mm / in)

29 / 1.0

29 / 1.0

23 / 0.8

55 / 1.94

Weight (net)
(g / oz)

±45MOA

±45MOA

±45MOA

±45MOA

Elevation
Range

±45MOA

±45MOA

±45MOA

±45MOA

Windage
Range

MGT™

MGT™

MGT™

MGT™

Footprint

9 levels R
&
2NV

9 levels R
&
2NV

9 levels R
&
2NV

9 levels R
&
2NV

Dot Intensity

CR1620

CR1620

CR1632

CR1632

Battery Type

Side

Side

Side

Side

Battery
Placement

5000

5000+

5000

5000

Runtime
(Hrs)

MGT™

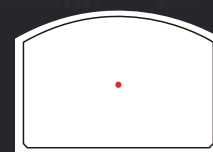
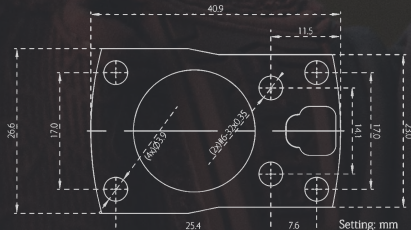

3MOA Red Dot



With Paragon Prism Scope



Offset Picatinny Mount
SCFRM-03



Riser Weaver Mount
SCRA-73

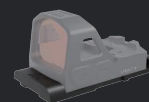

MOS to MAG Adapter
SCFRM-16

FRENZY / 57

FRENZY-X

Aspheric lens minimize the aberration & free of image distortion.
Provide multi-reticle with solar power edition.

MOJ™

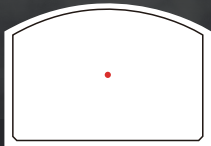
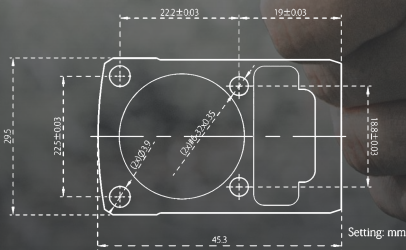

3MOA Red Dot

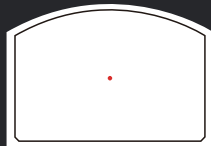

2MOA Red Dot

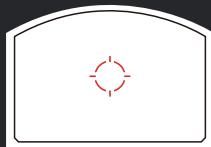

Crosshair Circle

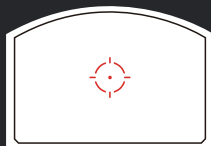

Dot + Crosshair Circle

1x20x28

SCRD-64

Aspheric Lens

1x20x26

SCRD-SM64

Aspheric Lens

1x19x28

SCRD-T64

1x24x29

SCRD-76

Reticle	3MOA	Multi-Reticle	Multi-Reticle	3MOA
Finish	Black Matte	Black Matte	Black Matte	Black Matte
Housing Material	7075	7075	Ti alloy	7075
Auto Light Sensor	N/A	N/A	N/A	N/A
Motion Sensor	Yes	Yes	Yes	Yes
Length (mm / in)	46 / 1.8	49 / 1.9	48.5 / 1.9	51 / 2.0
Weight (net) (g / oz)	43 / 1.51	45 / 1.58	56 / 1.97	43 / 1.1
Elevation Range	>45MOA	>45MOA	>45MOA	>90MOA
Windage Range	>45MOA	>45MOA	>45MOA	>90MOA
Footprint	MOJ™	MOJ™	MOJ™	MOJ™
Dot Intensity	11 levels R	11 levels R	11 levels R	8 levels R & 2NV
Battery Type	CR2032	CR2032	CR1632	CR2032
Battery Placement	Side Door	Side Door	Side Door	Side Door
Runtime (Hrs)	50000	50000	50000	20000



Offset Picatinny Mount
SCFRM-02



Riser Weaver Mount
SCRA-71

58

/ FRENZY

FRENZY-PLUS

Battery side-loading & audible click 1MOA adjustment provide multi-reticle with solar power edition, deal for shotgun and carbine platform.

1x22x32
SCRD-SM44

1x22x32
SCRD-65

Multi-Reticle

6MOA

Reticle

Black Matte

Black Matte

Finish

6061

6061

Housing
Material

Yes

N/A

Solar
Power

Yes

Yes

Motion
Sensor

53 / 2.08

53 / 2.08

Length
(mm / in)

113 / 3.96

112 / 3.96

Weight (net)
(g / oz)

> 50MOA

> 50MOA

Elevation
Range

±50MOA

±50MOA

Windage
Range

Quick Release

Quick Release

Mount Type

8 levels R
&
2NV8 levels R
&
2NV

Dot Intensity

CR2032

CR2032

Battery Type

Side Door

Side Door

Battery
Placement

80000

30000

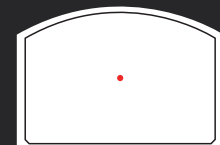
Runtime
(Hrs)

3MOA Red Dot

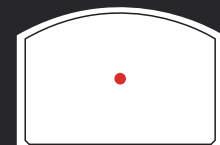

6MOA Red Dot



Crosshair Circle



Dot + Crosshair Circle



1x22x32 Riser Mount
SCFRM-24

FRENZY-PLUS

All weather conditions in heavy-duty construction. It features a motion sensor & IP67 waterproof. Provide multi-reticle with solar power edition. Skeleton armor shroud with quick release mount.

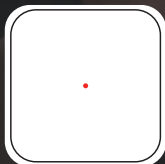

3MOA Red Dot



Standard Crosshair



Crosshair Circle



Dot + Crosshair Circle



1x31x26 Skeleton Armor Shroud
SCRD-67A1 | SCRD-67A2



SCRD-67A3 | SCRD-67A4



	1x31x26 SCRD-67	1x31x26 SCRD-M67	1x31x26 SCRD-S67	1x31x26 ^{45w} SCRD-SM67
Reticle	3MOA	Multi-Reticle	3MOA	Multi-Reticle
Finish	Black Matte	Black Matte	Black Matte	Black Matte
Housing Material	7075	7075	7075	7075
Solar Power	N/A	N/A	Yes	Yes
Motion Sensor	Yes	Yes	Yes	Yes
Length (mm / in)	94.6 / 3.72	94.6 / 3.72	94.6 / 3.72	94.6 / 3.72
Weight (net) (g / oz)	297 / 10.5	297 / 10.5	297 / 10.5	297 / 10.5
Elevation Range	± 90MOA	± 90MOA	± 90MOA	± 90MOA
Windage Range	± 90MOA	± 90MOA	± 90MOA	± 90MOA
Mount Type	Quick Release	Quick Release	Quick Release	Quick Release
Dot Intensity	9 levels R & 2NV	9 levels R & 2NV	9 levels R & 2NV	9 levels R & 2NV
Battery Type	AAAx2	AAAx2	AAAx2	AAAx2
Battery Placement	Front	Front	Front	Front
Runtime (Hrs)	50000	50000	50000+	50000+
Center Height (mm / in)	40 / 1.57	40 / 1.57	40 / 1.57	40 / 1.57
Compatible Magnifier		Maverick 3x26 Magnifier SM SCMF-11		

60 / FRENZY

FRENZY-PLUS

Full support for all conditions, whether in sand, rain, or snow. It features a motion sensor & provides multi-reticle & solar power edition – versatile accessories for different pistol platforms and picatinny rail.

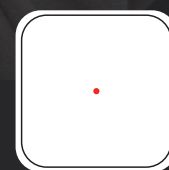
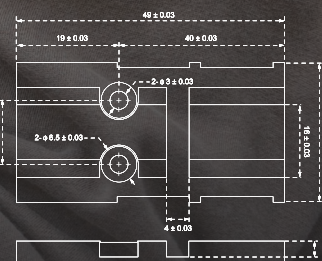

3MOA Red Dot

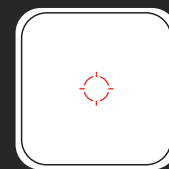

Crosshair Circle



Dot + Crosshair Circle



1x18x22 Flip-Up Caps
SCFRM-25

1x18x20 SCRD-63	1x18x20 SCRD-F63	1x18x20 SCRD-SM63	1x18x22 ^{4C.W} SCRD-75	1x18x22 ^{4C.W} SCRD-SM75	
3MOA	3MOA	Multi-Reticle	3MOA	Multi-Reticle	Reticle
Black Matte	FDE	Black Matte	Black Matte	Black Matte	Finish
6061	6061	6061	7075	7075	Housing Material
N/A	N/A	Yes	N/A	Yes	Solar Power
Yes	Yes	Yes	Yes	Yes	Motion Sensor
46 / 1.8	46 / 1.8	46 / 1.8	31.6 / 1.2	31.6 / 1.2	Length (mm / in)
81 / 2.9	81 / 2.9	81 / 2.9	65 / 2.2	65 / 2.2	Weight (net) (g / oz)
±45MOA	±45MOA	±45MOA	±50MOA	±50MOA	Elevation Range
±45MOA	±45MOA	±45MOA	±50MOA	±50MOA	Windage Range
VOO™	VOO™	VOO™	VOO™	VOO™	Footprint
8 levels R & 2NV	8 levels R & 2NV	8 levels R & 2NV	9 levels R & 2NV	9 levels R & 2NV	Dot Intensity
CR2032	CR2032	CR2032	CR2032	CR2032	Battery Type
Side Door	Side Door	Side Door	Side Door	Side Door	Battery Placement
50000	50000	50000	50000	50000	Runtime (Hrs)

VOD

FOOTPRINT



- MOS to VOD Adapter
SCFRM-12



- MOJ to VOD Adapter
SCFRM-13



- CZ Shadow 2 VOD Adapter
SCFRM-18



- VOD Red Dot Low Weaver Mount
SCFRM-14



- Riser Weaver Mount
SCFRM-15



- Low Dovetail Mount
SCFRM-17



- HK SFP9 VOD Adapter
SCFRM-20



FRENZY-X

High-end sight built with parallax free and premium coating. Up to 50,000 or more-hour battery runtime. Features 3MOA clear red or green dot with IPX6 waterproof.



1x20x28 SCRD-35 **1x20x28** SCRD-40 **1x17x24** SCRD-19II **1x17x24** SCRD-G19II

TEK™

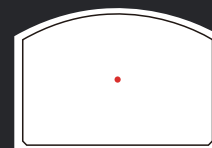
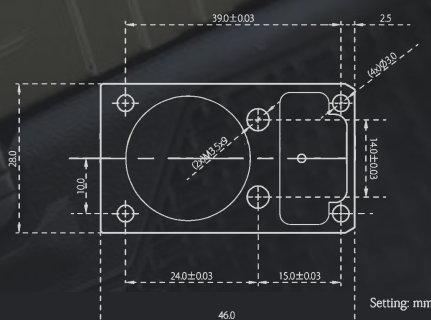

3MOA Red Dot

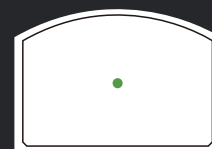

5MOA Green Dot

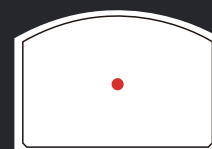

6MOA Red Dot

3MOA	6MOA	3MOA	5MOA	Dot Size
Black Matte	Black Matte	Black Matte	Black Matte	Finish
6061	6061	6061	6061	Housing Material
N/A	N/A	N/A	N/A	Auto Light Sensor
N/A	N/A	N/A	Yes	Motion Sensor
46 / 1.8	46 / 1.8	46 / 1.8	46 / 1.8	Length (mm / in)
26 / 1.0	26 / 1.0	26 / 0.9	26 / 0.9	Weight (net) (g / oz)
>45MOA	>45MOA	>45MOA	>45MOA	Elevation Range
>45MOA	>45MOA	>45MOA	>45MOA	Windage Range
TEK™	TEK™	TEK™	TEK™	Footprint
8 levels R & 2NV	8 levels R & 2NV	8 levels R & 2NV	8 levels G & 2NV	Dot Intensity
CR2032	CR2032	CR2032	CR2032	Battery Type
Bottom	Bottom	Bottom	Bottom	Battery Placement
50000	50000	50000	50000	Runtime (Hrs)



Dovetail Mount TEK SCFRM-04



Offset Picatinny Mount SCFRM-01



Riser Weaver Mount SCRA-67

FREZY / 63

FREZY-X

High-end sight built with parallax free and premium coating. Up to 50,000 or more-hour battery runtime. Provides versatile options for multi-reticle, motion sensor.



1x22x26
SCRD-36

1x22x26
SCRD-M36

1x22x26
SCRD-37

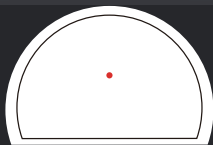
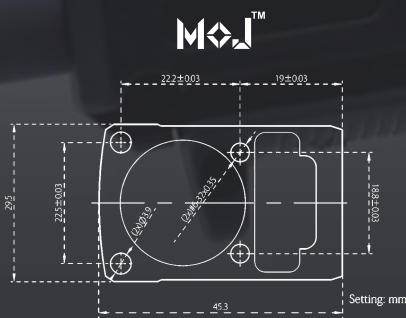

3MOA Red Dot

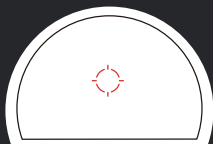

Crosshair Circle

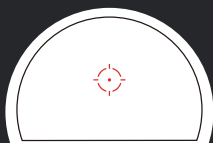

Dot + Crosshair Circle

	1x22x26 SCRD-36	1x22x26 SCRD-M36	1x22x26 SCRD-37
Reticle	3MOA	Multi-Reticle	3MOA
Finish	Black Matte	Black Matte	Black Matte
Housing Material	6061	6061	6061
Auto Light Sensor	N/A	N/A	Yes
Motion Sensor	Yes	Yes	N/A
Length (mm / in)	50 / 2.0	50 / 2.0	50 / 2.0
Weight (net) (g / oz)	30 / 1.1	30 / 1.1	30 / 1.1
Elevation Range	>45MOA	>45MOA	>45MOA
Windage Range	>45MOA	>45MOA	>45MOA
Footprint	MOJ™	MOJ™	MOJ™
Dot Intensity	8 levels R & 2NV	8 levels R & 2NV	8 levels R & 2NV
Battery Type	CR2032	CR2032	CR2032
Battery Placement	Bottom	Bottom	Bottom
Runtime (Hrs)	50000	50000	50000



Offset Picatinny Mount
SCFRM-02



Riser Weaver Mount
SCRA-71

64 / FRENZY

FRENZY-S

High-end slim profile sight built with parallax free & premium coating. Up to 50,000 or more-hour battery runtime. Provides options for multi-reticle, battery side-load, motion sensor, or auto-light sense with versatile finish options.



1x17x24
SCRD-43

1x17x24
SCRD-M43

1x17x24
SCRD-G43

3MOA

Multi-Reticle

5MOA

Dot Size

Black Matte

Black Matte

Black Matte

Finish

6061

6061

6061

Housing Material

N/A

N/A

N/A

Auto Light Sensor

Yes

Yes

Yes

Motion Sensor

41 / 1.6

41 / 1.6

41 / 1.6

Length (mm / in)

18 / 0.6

18 / 0.6

18 / 0.6

Weight (net) (g / oz)

>45MOA

>45MOA

>45MOA

Elevation Range

>45MOA

>45MOA

>45MOA

Windage Range

MGT™

MGT™

MGT™

Footprint

8 levels R & 2NV

8 levels R & 2NV

8 levels G & 2NV

Dot Intensity

CR2032

CR2032

CR2032

Battery Type

Bottom

Bottom

Bottom

Battery Placement

50000

20000

40000

Runtime (Hrs)

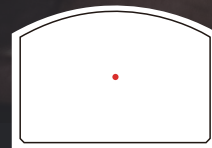
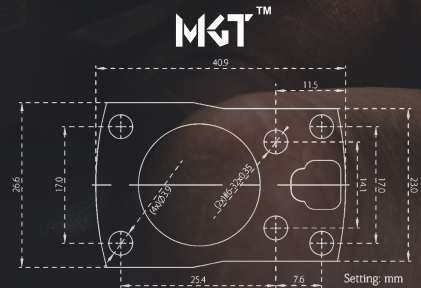

3MOA Red Dot

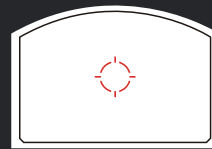

Crosshair Circle

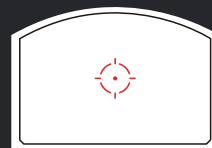

Dot + Crosshair Circle

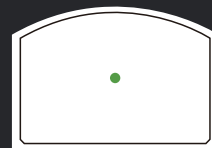

5MOA Green Dot



Offset Picatinny Mount
SCFRM-03



Riser Weaver Mount
SCRA-73



SCRAPPER mini



1x20



SCRD-69

Lower 1/3 Co-witness

1x25

SCRD-74

Absolute Co-witness

3MOA	3MOA	Reticle
Black Matte	Black Matte	Finish
7075 T6	7075 T6	Housing Material
N/A	N/A	Solar Panels
Yes	Yes	Motion Sensor
47 / 1.85	60 / 2.36	Length (mm / in)
123 / 4.33	287 / 10.12	Weight (net) (g / oz)
>45MOA	>45MOA	Elevation Range
>45MOA	>45MOA	Windage Range
Picatinny Mount		Mount Type
8 levels R 駁 2NV	8 levels R 駁 2NV	Dot Intensity
CR2032	CR2032	Battery Type
 40.4 / 1.57	 36 / 1.42	Center Hight (mm / in)
Paragon 3x18 & 5x30 SCMF-33 SCMF-34		Compatible Magnifier

RUM™

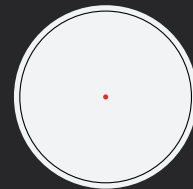
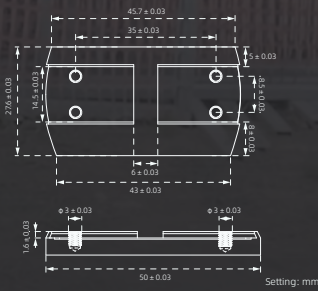

3MOA Red Dot



1x20 Cantilever Picatinny QD Mount
RD69-QD01



1x25 Cantilever Picatinny QD Mount
RD74-QD01

SCRAPPER

Compact, rugged, lightweight construction with IP67 waterproof. Direct bulb RCLED & US made chip ensure the dot clear and easy to see for rapid acquisition of targets.

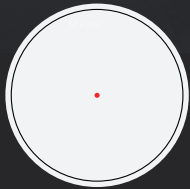
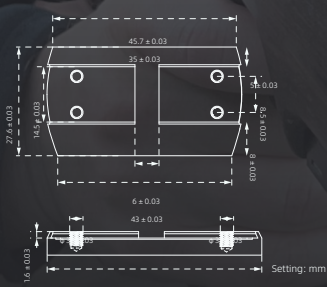



3MOA Red Dot

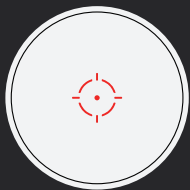

Crosshair Circle



Dot + Crosshair Circle

	1x22 SCRD-45 <i># Lower 1/3 Co-witness</i>	1x22 SCRD-SM45	1x25 SCRD-46 <i># Absolute Co-witness</i>	1x25 SCRD-SM46	1x29 SCRD-47 <i># 1.5" Center Dot Height</i>
Reticle	3MOA	Multi-Reticle	3MOA	Multi-Reticle	3MOA
Finish	Black Matte	Black Matte	Black Matte	Black Matte	Black Matte
Housing Material	6061-T6	6061-T6	6061-T6	6061-T6	6061-T6
Solar Panels	N/A	Yes	N/A	Yes	N/A
Motion Sensor	Yes	Yes	Yes	Yes	Yes
Length (mm / in)	64 / 2.5	65 / 2.52	70 / 2.7	60 / 2.52	80 / 3.1
Weight (net) (g / oz)	140 / 4.9	143 / 5.0	190 / 6.7	143 / 5.0	200 / 7.1
Elevation Range	±45MOA	±45MOA	±45MOA	±45MOA	>45MOA
Windage Range	±45MOA	±45MOA	±45MOA	±45MOA	>45MOA
Mount Type	Picatinny Mount				
Dot Intensity	8 levels R & 2NV	8 levels R & 2NV	8 levels R & 2NV	8 levels R & 2NV	8 levels R & 2NV
Battery Type	CR2032	CR2032	CR2032	CR2032	CR2032
Center Hight (mm / in)	 40.4 / 1.59	 40.4 / 1.59	 36 / 1.42	 36 / 1.42	 27.5 / 1.0
Compatible Magnifier	Paragon 3x18 & 5x30 SCMF-33 SCMF-34				



RD45-FC01
Transparent 28mm
Scope Flip-Cap



RD46-FC01
Transparent 36mm
Scope Flip-Cap



RD47-FC01
Transparent 37mm
Scope Flip-Cap



RD47-FC02
Transparent 37.5mm
Scope Flip-Cap

— CLASSIC LINE —



CLASSIC LINE

5-year Warranty



NAUTILUS



Our classic product line is the ideal choice for those looking for a reliable option that offers a balance of performance and affordability.

These products come with a reassuring 5-year warranty, providing peace of mind throughout your shooting adventures.

70 / NAUTILUS

NAUTILUS

Closed red dot scope by using AAA battery with Quick Release Mount.



1x30

SCRD-26II

Absolute Co-witness

1x30

SCRD-D26

Absolute Co-witness

3MOA	Double Reticles	Reticle
Black Matte	Black Matte	Finish
6061	6061	Housing Material
Yes	N/A	Auto Light Sensor
N/A	Yes	Motion Sensor
N/A	N/A	Solar Panels
110 / 4.3	98 / 3.9	Length (mm / in)
270 / 9.5	270 / 9.5	Weight (net) (g / oz)
>60MOA	>60MOA	Elevation Range
>60MOA	>60MOA	Windage Range
Picatinny Quick Release		Mount Type
11 levels R	7 levels R & 2NV	Dot Intensity
AAA	AAA	Battery Type
 38 / 1.5	 38 / 1.5	Center Height (mm / in)
Maverick 3x26 & 4x26 & 5x26 & 3x22 Paragon 3x18 & 5x30 SCMF-10 SCMF-11 SCMF-14 SCMF-15 SCMF-31 SCMF-32 SCMF-41 SCMF-33 SCMF-34		Compatible Magnifier

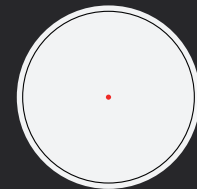

3MOA Red Dot

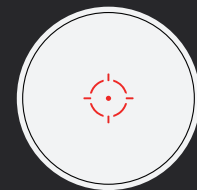

Circle + Crosshair Dot



— ENTRY LINE —



ENTRY LINE

5-year Warranty



MAVERICK

OMEGA



Our entry-level product line is perfect for beginners and casual shooters who prioritize affordability without compromising on quality.

These products provide a great starting point and come with the added assurance of a generous 5-year warranty.

MAVERICK-II

Most sold 3MOA red dot scope with direct 1MOA turret adjustment. Come with a picatinny quick release riser mount for the AR platform and a low picatinny mount for your other tactical or hunting calibers.



1x22 SCRD-12II	1x22 SCRD-GY12	1x22 SCRD-PS12	1x22 SCRD-PD12	1x25 SCRD-72	
3MOA	3MOA	3MOA	Double Reticles	3MOA	Reticle
Black	Graphite Finish	Black	Black	Black	Finish
6061	6061	6061	6061	6061	Body Material
N/A	N/A	Yes	N/A	N/A	Solar Panels
N/A	N/A	N/A	Yes	Yes	Motion Sensor
76 / 3.0	76 / 3.0	76 / 3.0	76 / 3.0	92 / 3.62	Length (mm / in)
185 / 6.5	185 / 6.5	185 / 6.5	185 / 6.5	212 / 7.5	Weight (net) (g / oz)
>45MOA	>45MOA	>45MOA	>45MOA	>45MOA	Elevation Range
>45MOA	>45MOA	>45MOA	>45MOA	>45MOA	Windage Range
Picatinny Quick Release Riser Mount & Lower Weaver Mount					Mount Type
11 levels R	11 levels R	7 levels R & 1NV	8 levels R & 1NV	6 levels R	Dot Intensity
CR2032	CR2032	CR2032	CR2032	CR2032	Battery Type
38 / 1.5	38 / 1.5	38 / 1.5	38 / 1.5	38 / 1.5	Center Hight (mm / inch)
Maverick 3x26 & 4x26 & 5x26 & 3x22 SCMF-10 SCMF-11 SCMF-14 SCMF-15 SCMF-31 SCMF-32 SCMF-41					Compatible Magnifier

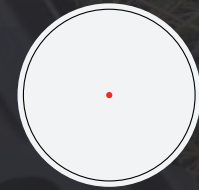

3MOA Red Dot



Dot + Crosshair Circle



Absolute Co-witness



RD45-FC01
Transparent 28mm
Scope Flip-Cap



RD46-FC01
Transparent 36mm
Scope Flip-Cap

MAVERICK-III

3MOA red dot scope with capped 1MOA adjustment, lightweight solid construction, and rubber armor provide great protection for red dot scope.



	1x22 SCRD-41 ○	1x22 SCRD-42 ○	1x22 SCRD-38 ○	1x22 SCRD-39 ○
--	-----------------------------	-----------------------------	-----------------------------	-----------------------------

Reticle	3MOA	3MOA	3MOA	3MOA
Finish	Black Rubber Armored	FDE Rubber Armor	Black Rubber Armored	FDE Rubber Armor
Body Material	6061	6061	6061	6061
Solar Panels	N/A	N/A	N/A	N/A
Motion Sensor	N/A	N/A	N/A	N/A
Length (mm / in)	76 / 3.0	76 / 3.0	76 / 3.0	76 / 3.0
Weight (net) (g / oz)	185 / 6.5	185 / 6.5	185 / 6.5	185 / 6.5
Elevation Range	>45MOA	>45MOA	>45MOA	>45MOA
Windage Range	>45MOA	>45MOA	>45MOA	>45MOA
Mount Type	Picatinny Riser Mount & Lower Weaver Mount		Picatinny Quick Release Riser Mount & Lower Weaver Mount	
Dot Intensity	11 levels R	11 levels R	11 levels R	11 levels R
Battery Type	CR2032	CR2032	CR2032	CR2032
Center Hight (mm / inch)	41 / 1.6	41 / 1.6	41 / 1.6	41 / 1.6
Compatible Magnifier	Maverick-III 3x22 (SCMF-31 SCMF-32)			

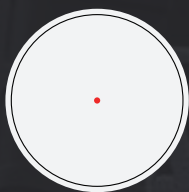

3MOA Red Dot



Absolute Co-witness



RD45-FC01
Transparent 28mm
Scope Flip-Cap



RD46-FC01
Transparent 36mm
Scope Flip-Cap

MAVERICK-IV

The most compact red dot scope in the Maverick line. Feature 3MOA dot size & premium coating lens.



1x20 SCRD-60	1x20 SCRD-61	
3MOA	3MOA	Reticle
Black Rubber Armored	FDE Rubber Armor	Finish
6061	6061	Body Material
N/A	N/A	Solar Panels
N/A	N/A	Motion Sensor
68 / 2.7	68 / 2.7	Length (mm / in)
140 / 4.9	140 / 4.9	Weight (net) (g / oz)
>45MOA	>45MOA	Elevation Range
>45MOA	>45MOA	Windage Range
Picatinny Quick Release Mount & Lower Mount		Mount Type
10 levels R	10 levels R	Dot Intensity
CR2032	CR2032	Battery Type
41 / 1.6	41 / 1.6	Center Hight (mm / inch)
Maverick 3x26 (SCMF-11)		Compatible Magnifier

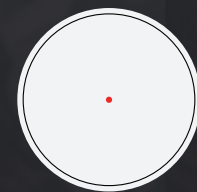

3MOA Red Dot



Absolute Co-witness

MAVERICK

Accessories



MAV-QD10

0.8" Profile Cantilever QD Riser Mount

Fit Maverick & Scrapper Red Dot Scope

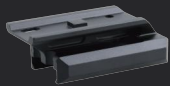

0.5" Profile Cantilever Picatinny Riser Mount

MAV-P05

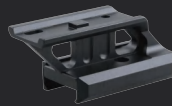

0.83" Profile Cantilever Picatinny Riser Mount

MAV-P08

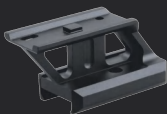

1.0" Profile Cantilever Picatinny Riser Mount

MAV-P10

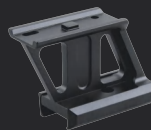

1.5" Profile Cantilever Picatinny Riser Mount

MAV-P15



Low Profile Dovetail Mount

MAV-DL

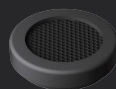

Maverick Gen-IV Honeycomb Sunshade

SCRD-61A1

AND MORE...

OMEGA

Multi-reticle open reflex sight with green / red illumination and picatinny quick release mount for AR platform.



1x23x33
SCRD-48

1x27x39
SCRD-04

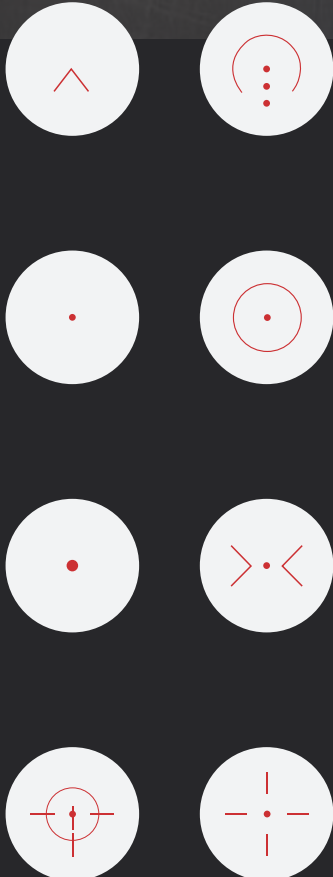

Reticle	Four-Reticle	Eight-Reticle
Finish	Black Matte	Black Matte
Housing Material	6061	6061
Auto Light Sensor	N/A	N/A
Motion Sensor	N/A	N/A
Length (mm / in)	88 / 3.5	110 / 4.1
Weight (net) (g / oz)	190 / 6.7	260 / 9.2
Elevation Range	80MOA	>60MOA
Windage Range	80MOA	>60MOA
Mount Type	Picatinny Quick Release	
Dot Intensity	6 levels R & G	6 levels R & G
Battery Type	CR2032	CR2032



MAGNIFIER

SCRAPPER & MAVERICK

80 / PARAGON MAGNIFIER

PARAGON MAGNIFIER

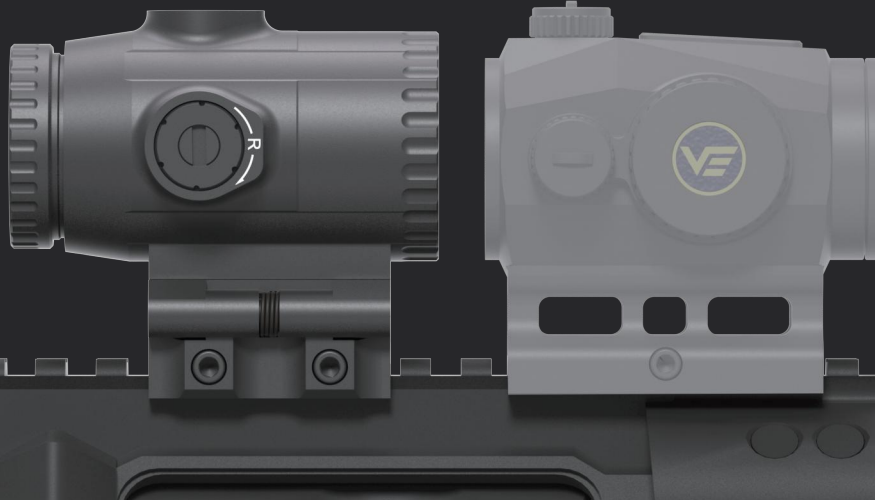

3x18
SCMF-33

5x30
SCMF-34



Magnification

3x

5x

**Objective
Lens Dia (mm)**

18

30

**Exit Pupil
(mm)**

6.0

6.0

**F.O.V
(ft @100yds)**

39

23

**F.O.V
(m @100meters)**

11.9

7.0

**Eye Relief
(mm / in)**

67 / 2.6

67 / 2.6

**Length
(mm / in)**

70 / 2.8

93 / 3.7

**Weight
(net)(g/oz)**

215 / 7.6

250 / 8.8

**Center Height
(mm / in)**

36 / 1.4

36 / 1.4



MAVERICK MAGNIFIER / 81

MAGNIFIER

MAVERICK



3x26
SCMF-10

3x26
SCMF-11

4x26
SCMF-14

5x26
SCMF-15

3x22
SCMF-31

3x22
SCMF-32



	3x26 SCMF-10	3x26 SCMF-11	4x26 SCMF-14	5x26 SCMF-15	3x22 SCMF-31	3x22 SCMF-32
Magnification	3x	3x	4x	5x	3x	3x
Objective Lens Dia (mm)	26	26	26	26	22	22
Exit Pupil (mm)	7.0	7.0	6.5	6.5	7.0	7.0
F.O.V (ft @100yds)	49	49	26	20.3	49	49
F.O.V (m @100meters)	14.9	14.9	7.9	6.2	14.9	14.9
Eye Relief (mm / in)	60 / 2.4	60 / 2.4	75 / 3.0	70 / 2.8	69 / 2.7	69 / 2.7
Length (mm / in)	108 / 4.2	108 / 4.2	115 / 4.5	118 / 4.6	103 / 4.1	103 / 4.1
Weight (net)(g/oz)	325 / 11.7	440 / 15.5	230 / 8.1	230 / 8.1	290 / 10.2	290 / 10.2
Center Height (mm / in)	36 / 1.4	39 / 1.5	36 / 1.4	36 / 1.4	36 / 1.4	36 / 1.4



NATURE OBSERVATION

Binocular, Range Finder Binocular, Spotting Scope, Range Finder, Monocular



THREAD RING
Ø 40.00 ± 0.02
CE MARK
ISO 9001:2015
PROMAX 2100000
10-01-17
CROSSHAIR OPTICS

GHOST

New CONTINENTAL

ED BINOCULAR



90% Light
Transmission



ED Glass
(Extra-Low Dispersion)



Fully Multi-Coated



IP67 Water Proof



BINOCULAR

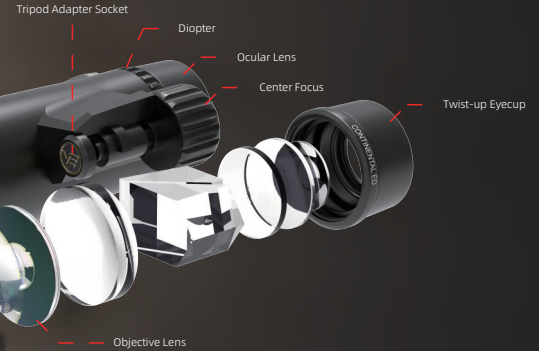

Sku	Name	Prism Type	Focus Type	Field of View (m @1000m / ft @1000yds)	Objective Lens Dia (mm / in)	Dimensions (mm / inch)	Weight (net) (g / oz)	Exit Pupil (mm)
SCBO-05	8x42 ED	BAK4 Roof Prism	Center	142 / 426	42 / 1.65	147x55x130 / 5.7x2.1x5.1	840 / 29.6	5.25
SCBO-06	10x42 ED	BAK4 Roof Prism	Center	131 / 366	42 / 1.65	147x55x130 / 5.7x2.1x5.1	840 / 29.6	4.2
SCBO-07	10x42 ED (Reticle)	BAK4 Roof Prism	Center	131 / 366	42 / 1.65	147x55x130 / 5.7x2.1x5.1	804 / 28.4	4.2
SCBO-08	12x50 ED	BAK4 Roof Prism	Center	94 / 282	50 / 1.96	140x60x176 / 5.5x2.36x6.92	1230 / 43.4	4.17
New SCBO-09	15x56 ED	Abbe-König Prism	Center	70 / 210	56 / 2.2	190x160x68 / 7.48x6.29x2.67	1410 / 49.7	3.7
New SCBO-10	8x56 ED	Abbe-König Prism	Center	126 / 378	56 / 2.2	190x160x68 / 7.48x6.29x2.67	1200 / 42.3	7
SCBO-14	8x42 ED (OD Green)	BAK4 Roof Prism	Center	142 / 426	42 / 1.65	147x55x130 / 5.7x2.1x5.1	840 / 29.6	5.25
SCBO-15	10x42 ED (OD Green)	BAK4 Roof Prism	Center	131 / 366	42 / 1.65	147x55x130 / 5.7x2.1x5.1	840 / 29.6	4.2

BINOCULAR



8x42



10x42 HD

SKU	Name	Prism Type	Focus Type	Field of View (ft @1000yds / m @1000m)	Objective diameter (mm)	Dimensions (mm / inch)	Weight (net) (g / oz)	Exit Pupil (mm)
SCBO-03	8x42	Roof Prism	Center	347 / 116	42	146x54x128 / 5.7x2.1x5.0	685 / 24.2	5.1
SCBO-04	10x42	Roof Prism	Center	366 / 131	42	146x54x128 / 5.7x2.1x5.0	675 / 23.8	4.1
SCBO-12	8x42	Roof Prism	Center	323 / 108	42	150x54x114 / 5.9x2.1x4.5	585 / 20.6	5.25
SCBO-13	10x42	Roof Prism	Center	299 / 100	42	150x54x114 / 5.9x2.1x4.5	582 / 20.5	4.2

BINOCULAR



SKU	Name	Prism Type	Focus Type	Field of View (ft @1000yds / m @1000m)	Objective diameter (mm)	Dimensions (mm / inch)	Weight (net) (g / oz)	Exit Pupil (mm)
SCBO-01	8x42	Roof	Center	338 / 113	42	147x53x126 / 5.7x2.0x4.9	620 / 21.9	5.1
SCBO-02	10x42	Roof	Center	300 / 102	42	147x53x126 / 5.8x2.0x4.9	620 / 21.9	4.1
SCBO-16	7x50	Porro	Center	366 / 122	50	179x190x62 / 7.0x7.4x2.44	850 / 30	7.1
SCBO-17	10x50	Porro	Center	340 / 113	50	179x190x62 / 7.0x7.4x2.44	850 / 30	5
SCBO-18	12x50	Porro	Center	303 / 101	50	179x190x62 / 7.0x7.4x2.44	850 / 30	4.1

Binocular Universal Parts



RokStad Binocular Rest Tray Mount Black
RSBR-01



RokStad Binocular Rest Tray Mount Wooden
RSBR-02

New

RANGE FINDER BINOCULAR



Paragon 10x42SCBRF-02

Prism Glass	Focusing System	Exit Pupil (mm)	Field of View (@ 1000 yds)	Field of View (@ 1000 m)	Range to Reflective Target (yd)	Range to the Building (Concrete)	Range to Big Trees (yd)
BK-7 Prism	Central	4.2	278 ft	93 m	≥2500	≥1700 yd	≥1500
Range to Deer(yd)	Scan Mode	Laser Type	Waterproof	Housing Material	Weight (g/oz)	Length (mm / inch)	Battery Type
≥800	Yes, <2s	Laser Diodes 905nm	IP67	PPS Plastic	862 / 30.4	157 / 6.18	CR2

Forester 10x42 | SCBRF-01

Prism Glass	Focusing System	Exit Pupil (mm)	Field of View (@ 1000 yds)	Field of View (@ 1000 m)	Range to Reflective Target (yd)	Range to the Building (Concrete)	Range to Big Trees (yd)
BaK-4 Prism	Central	4.2	240 ft	80 m	≥1500	≥1300	≥1000
Range to Deer(yd)	Scan Mode	Laser Type	Waterproof	Housing Material	Weight (g/oz)	Length (mm / inch)	Battery Type
≥600	Yes	Laser Diodes 905nm	IP65	PPS Plastic	1043 / 36.8	163 / 6.42	CR2

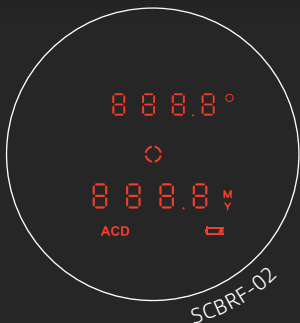

SPOTTING SCOPE

SCSSA-01
Continental Pro Spotting
Scope Armour



Continental 12-40x60 SCSS-02 PRO

Length (mm / in) : 318 / 13.38
Weight (net) (g / oz) : 1661 / 58.59

Material
Mg-Alu
Alloy Body

**Focus
Type**
Focus
Ring

**Exit Pupil
(mm)**
3.0-1.0

**Field of View
(ft @100yds)**
17.7-5.7

**Field of View
(m @100m)**
5.9-1.9

**Eye Relief
(mm / inch)**
30 / 1.18



Continental 20-60x80 SCSS-03 PRO

Length (mm / in) : 390 / 15.35
Weight (net) (g / oz) : 2215 / 78.13

Material
Mg-Alu
Alloy Body

**Focus
Type**
Focus
Ring

**Exit Pupil
(mm)**
4.0-1.3

**Field of View
(ft @100yds)**
12.0-4.2

**Field of View
(m @100m)**
4.0-1.4

**Eye Relief
(mm / inch)**
30 / 1.18



Paragon 8-24x56 SCSS-10

Length (mm / in) : 185 / 7.3
Weight (net) (g / oz) : 673 / 23.7

Material
Rubber
Covered

**Focus
Type**
Focus
Ring

**Exit Pupil
(mm)**
6.2-2.1

**Field of View
(ft @100yds)**
25.8-13.2

**Field of View
(m @100m)**
8.6-4.4

**Eye Relief
(mm / inch)**
20.0-16.7
/ 0.79-0.65



Paragon 9-27x56 SCSS-11

Length (mm / in) : 196 / 7.7
Weight (net) (g / oz) : 729 / 25.7

Material
Rubber
Covered

**Focus
Type**
Focus
Ring

**Exit Pupil
(mm)**
6.2-2.1

**Field of View
(ft @100yds)**
24.1-12

**Field of View
(m @100m)**
8.0-4.0

**Eye Relief
(mm / inch)**
20.0-16.7
/ 0.79-0.65



Forester 20-60x60 SCSS-01

Length (mm / in) : 350 / 13.8
Weight (net) (g / oz) : 730 / 25.8

Material
ABS Body

**Focus
Type**
Prismatic

**Exit Pupil
(mm)**
3.0-1.0

**Field of View
(ft @100yds)**
10.0-5.0

**Field of View
(m @100m)**
3.0-1.6

**Eye Relief
(mm / inch)**
16.5-13
/ 0.65-0.51



90 / FORESTER PARAGON

RANGE FINDER

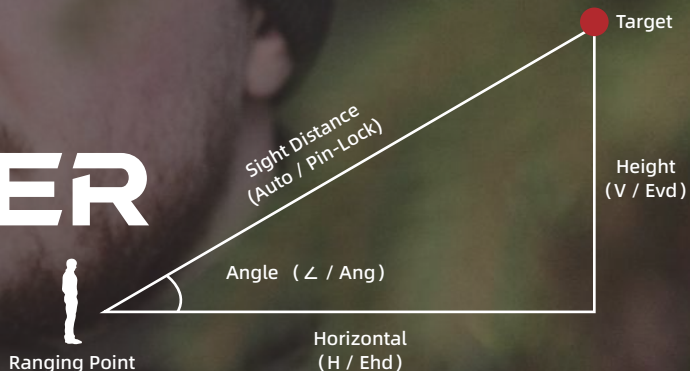

Forester 6x21 | SCRF-16 (3 modes)

Ranging Distance (m/ yds)	Ranging Response Time (s)	Exit Pupil (mm)	Field of View	Display	Size (mm / inch)	Weight (net) (g / oz)	Battery Type
5-1500 / 5-1600	0.25	15	6°	OLED	98.5x77x37 / 3.8x3x1.4	130 / 4.6	CR2-3V

Paragon 6x25 GENII | SCRF-20 (3 modes)

Ranging Distance (m/ yds)	Ranging Response Time (s)	Exit Pupil (mm)	Field of View	Display	Size (mm / inch)	Weight (net) (g / oz)	Battery Type
5-1850 / 5-2000	0.25	14	7°	LCD	105x76x42 / 4.1x3x1.6	180 / 6.3	CR2-3V



Paragon 6x25 GENIII BDC | SCRF-S20 (4 modes) Digital Ballistic

Ranging Distance (m/ yds)	Ranging Response Time (s)	Exit Pupil (mm)	Field of View	Display	Size (mm / inch)	Weight (net) (g / oz)	Battery Type
5-1850 / 5-2000	0.25	14	7°	OLED	105x76x42 / 4.1x3x1.6	140 / 4.9	CR2-3V



Paragon 7x24 GENIII BDC | SCRF-S24 (4 modes) Digital Ballistic

Ranging Distance (m/ yds)	Ranging Response Time (s)	Exit Pupil (mm)	Field of View	Display	Size (mm / inch)	Weight (net) (g / oz)	Battery Type
5-2194 / 5-2400	0.1	14	7°	OLED	118x76x42 / 4.65x3x1.6	184 / 6.49	CR2-3V



MONOCULAR



Ocular Lens
Cellphone Adapter
RSOA-01

Paragon 8x42 SCMO-01

Length (mm / in) : 141 / 5.55
Weight (net) (g / oz) : 388 / 13.69

Prism Type	Focus Type	Objective Lens Dia (mm /in)	Field of View (ft @100yds)	Field of View (m @100m)	Resolution
BAK4 Roof Prism	Manual	42 / 1.65	37.8	12.6	5.6"

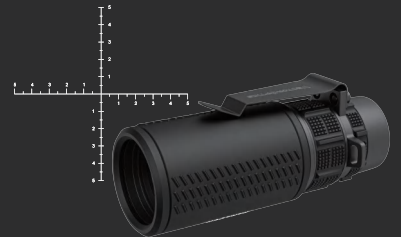

Forester 10x50 ED SCMO-02

Length (mm / inch) : 163 / 6.42
Weight (net) (g / oz) : 470 / 46.58

Prism Type	Focus Type	Objective Lens Dia (mm /in)	Field of View (ft @100yds)	Field of View (m @100m)	Resolution
BAK4 Roof Prism	Manual	50 / 1.97	31.5	10.5	4.5"

Forester 8x32 SCMO-03

Length (mm / in) : 130 / 5.11
Weight (net) (g / oz) : 190 / 0.67

Prism Type	Focus Type	Objective Lens Dia (mm /in)	Field of View (ft @100yds)	Field of View (m @100m)	Resolution
BAK4 Roof Prism	Manual	32 / 1.25	41.7	13.9	7.32"

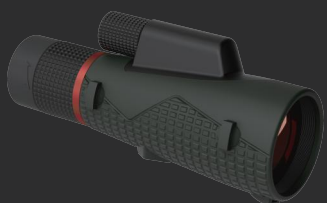

Forester 8-16x56 SCMO-04

Length (mm / in) : 193 / 7.6
Weight (net) (g / oz) : 491 / 1.08

Prism Type	Focus Type	Objective Lens Dia (mm /in)	Field of View (ft @100yds)	Field of View (m @100m)	Resolution
BAK4 Roof Prism	Manual	56 / 2.2	22.5-15.6	79-5.5	5"



VICTOPTICS

Qualified products, practical functions, competitive price

VICTOPTICS





10x Zoom



Shock Proof
Built to Endure



Fully Multi-coated



Turret Lock



30mm Tube



Nitrogen Purged

S10

SERIES

FEATURE

1-10x24 | 1-10x24i

- ▶ 30mm Monotube
- ▶ Edge-to-Edge Clarity
- ▶ Turret Lock Feature
- ▶ Fully Multi-coated
- ▶ Wide Field of View

SFP

New

1-10x24 OPSL37

Low Power Variable Optic
5 Levels R & G Illumination
1/10MIL Adjustment with Turret Lock Feature

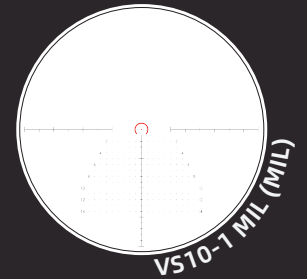
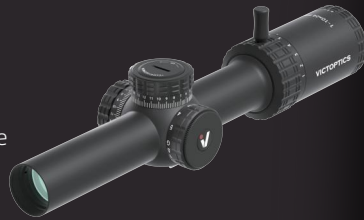

SFP

New

1-10x24i Fiber OPSL39

Low Power Variable Optic
5 Levels R Illumination
Fiber Center Dot Reticle
1/4MOA Adjustment

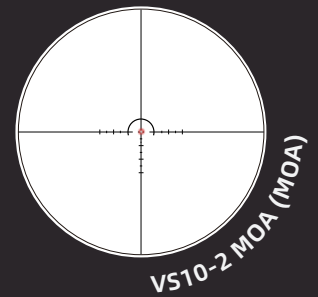

PRODUCT SPECS

SKU	Magnification	Objective Lens Dia	Exit Pupil (mm)	FO.V (ft @100yds)	Eye Relief (mm / in)	Length (mm / in)	Weight (net)(g / oz)	Tube	Elevation Range	Windage Range	Click Value	Parallax Adjustment	Reticle	Illumination
OPSL37	1-10x	24mm	14.0-5.0	104.2 / 14.1	100 / 4.0	274 / 10.8	588 / 20.7	30mm	>35MIL	>35MIL	1/10MIL	100yds	VS10-1 MIL	5 levels R & G
OPSL39				106.7 / 10.8			597 / 21.0		>120MOA	>120MOA	1/4MOA		VS10-2 MOA	5 levels R

6x
ZOOM

6x Zoom



Shock Proof
Built to Endure



Fully Multi-coated

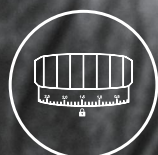

Turret Lock

30
MM

30mm Tube

N₂

Nitrogen Purged

36

SERIES

FEATURE

1-6x24 | 1-6x24i

- ▶ 30mm Monotube
- ▶ Edge-to-Edge Clarity
- ▶ Turret Lock Feature
- ▶ R & G Illumination
- ▶ Fully Multi-coated
- ▶ Wide Field of View

SFP

1-6x24 | 1-6x24 FDE OPSL22 | OPSL23

Low Power Variable Optic
5 Levels R & G Illumination
1/5MIL Adjustment with Turret Lock Feature



Available in Coyote FDE

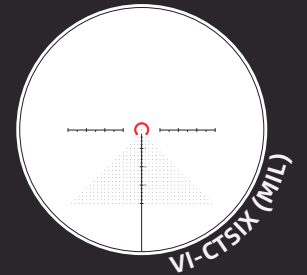

SFP

1-6x24i Fiber OPSL33

Low Power Variable Optic
6 Levels R Illumination
Fiber Center Dot Reticle
1/5MIL Adjustment with Turret Lock Feature

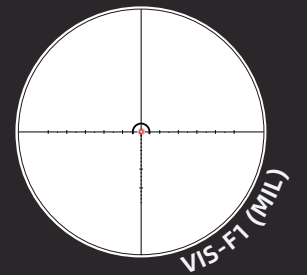

PRODUCT SPECS

SKU	Magnification	Objective Lens Dia	Exit Pupil (mm)	FO.V (ft @100yds)	Eye Relief (mm / in)	Length (mm / in)	Weight (net)(g / oz)	Tube	Elevation Range	Windage Range	Click Value	Parallax Adjustment	Reticle	Illumination
OPSL22													VI-CTSIX	5 levels R & G
OPSL23	1-6x	24mm	16.0-4.0	109.2 / 18.2	101 / 4.0	249 / 9.8	425 / 15.0	30mm	>50MIL	>50MIL	1/5MIL	100yds		
OPSL33													VIS-F1	6 levels R



Brian, USA

The S6 packs a lot into an affordable package. It's incredibly versatile and easy to use both up close and far away. The reticle is great for CQB and distance shooting. The glass is clear and the eye box and eye relief are forgiving.



4x Zoom



Shock Proof
Built to Endure

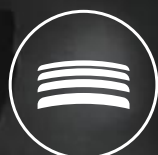

Fully Multi-coated



Turret Lock



30mm Tube



Nitrogen Purged

S4 SERIES

FEATURE

1.5-6x28 | 3-12x40 | 4-16x44 | 6-24x50

- ▶ 30mm Monotube
- ▶ Edge-to-Edge Clarity
- ▶ Turret Lock Feature
- ▶ Fully Multi-coated
- ▶ Wide Field of View



Shock Proof
Built to Endure



Fully Multi-coated



Turret Lock



Nitrogen Purged



SERIES

FEATURE

1.5-5x20 | 2-7x32 | 3-9x40 | 4-12x40

▶ Edge-to-Edge Clarity

▶ Turret Lock Feature

▶ Wide Field of View

▶ R & G Illumination

▶ Fully Multi-coated

SFP

1.5-5x20 VIOC-01

1" (25.4mm) Tube | Fully Multi Coated | 5 Levels R & G

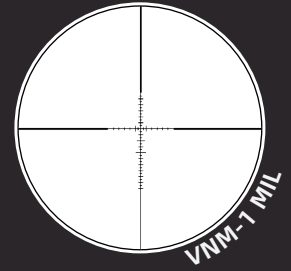

SFP

2-7x32 VIOC-02

1" (25.4mm) Tube | Fully Multi Coated | 5 Levels R & G



New

3-9x40 / AO VIOC-03 / VIOC-05

1" (25.4mm) Tube | Fully Multi Coated | 5 Levels R & G

SFP



New

4-12x40 / AO VIOC-04 / VIOC-06

Multi Coated | 5 Levels R & G

SFP



PRODUCT SPECS

SKU	Magnification	Objective Lens Dia	Exit Pupil (mm)	FO.V (ft @100yds)	Eye Relief (mm / in)	Length (mm / in)	Weight (net)(g / oz)	Tube	Elevation Range	Windage Range	Click Value	Parallax Adjustment	Reticle	Illumination
VIOC-01	1.5-5x	20mm	13.3-4.0	74.4-22.8		218 / 8.6	225 / 7.9				1/5MIL			
VIOC-02	2-7x	32mm	16.0-4.6	60.6-16.2	80.0 / 3.15	234 / 9.2	328 / 11.6		35MIL	35MIL		50yds		
VIOC-03	3-9x		13.3-4.4	28.2-10.2		305 / 12.0	447 / 15.8	1" 25.4mm	20MIL	20MIL			VNM-1 MIL	5 levels R & G
VIOC-04	4-12x		10.0-3.3	24.9-8.4	90.0 / 3.5	335 / 13.2	458 / 16.2				1/10MIL			
VIOC-05	3-9x	40mm	13.3-4.4	28.2-10.2	80.0 / 3.15	317 / 12.5	520 / 18.3		18MIL	18MIL		100yds		
VIOC-06	4-12x		10.0-3.3	24.9-8.4	90.0 / 3.5	351 / 13.8	580 / 20.4	30mm	20MIL	20MIL				

A1

4x20 OPSL07 (4x15 & 3-7x20 Available)
19mm Tube | Multi Coated | Weaver or Dovetail Mount

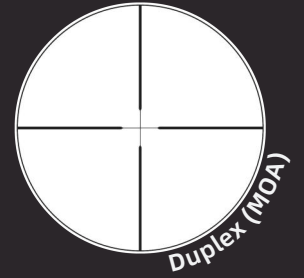

A1

4x32 OPSL19
1" (25.4mm) Tube | Multi Coated | 1/4MOA Adjustment



A3

2-6x32 OPSL09
1" (25.4mm) Tube | 5 Levels R & G | 1/4MOA Adjustment

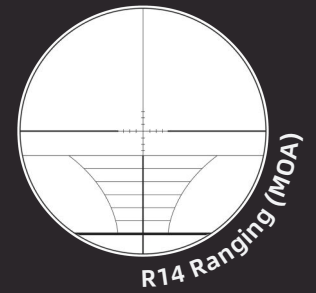

B1

4x32C OPSL25
1" (25.4mm) Tube | Multi Coated | 1/4MOA Adjustment



PRODUCT SPECS

SKU	Magnification	Objective Lens Dia	Exit Pupil (mm)	F.O.V (ft @100yds)	Eye Relief (mm / in)	Length (mm / in)	Weight (net)(g / oz)	Tube	Elevation Range	Windage Range	Click Value	Parallax Adjustment	Reticle	Illumination
OPSL07 <small>SFP</small>	4x	20mm	5.0	36.6	75 / 3.0	270 / 10.6	100 / 3.5	19mm	40MOA	40MOA	N/A	100yds	Duplex	N/A
OPSL19 <small>SFP</small>			7.5	30.4	80-70 / 3.1-2.8	292 / 11.5	280 / 11.0		90MOA	90MOA				
OPSL09 <small>SFP</small>	2-6x	32mm	4.6-14.0	15.7-42.0	75-95 / 3.0-3.7	210 / 8.3	360 / 12.7	1" 25.4mm	60MOA	60MOA	1/4MOA	10yds to ∞	R14 Ranging	5 levels R & G
OPSL25 <small>SFP</small>	4x		7.5	33.7	90 / 3.5	191 / 7.5	230 / 8.1		90MOA	90MOA		100yds		N/A

B3

3-9x40 OPSL20

1" (25.4mm) Tube | Multi Coated | 1/4MOA Adjustment

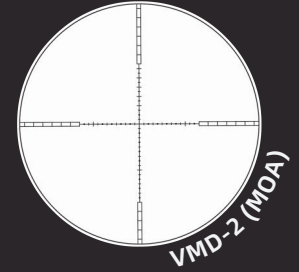

C3

3-9x32 OPSL28

1" (25.4mm) Tube | Turret Lock | R & G Illumination



SCB

2-5x24IR OPSL30

30mm Tube | BDC Crossbow Reticle | 5 levels R & G

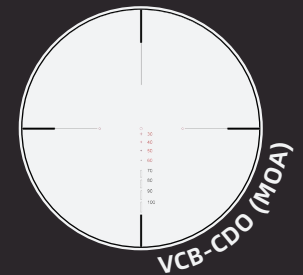

PRODUCT SPECS

SKU	Magnification	Objective Lens Dia	Exit Pupil (mm)	FO.V (ft @100yds)	Eye Relief (mm / in)	Length (mm / in)	Weight (net)(g / oz)	Tube	Elevation Range	Windage Range	Click Value	Parallax Adjustment	Reticle	Illumination
OPSL20 <small>SFP</small>	3-9X	40mm	13.3-4.4	34.6-12.6	78 / 3.1	310 / 12.2	370 / 13.0	1" 25.4mm	120MOA	120MOA	1/4MOA	100yds	VMD-2	N/A
OPSL28 <small>SFP</small>		32mm	10.6-3.8	37.0-12.5	120-76 / 4.0-3.0	208 / 83.2	380 / 13.4					10yds to ∞	MIL-DOT	Stepless R & G
OPSL30 <small>SFP</small>	2-5X	24mm	10.7-4.8	63.7-25.5	96 / 3.8	248 / 9.8	380 / 13.4	30mm	60MOA	60MOA	1/2MOA	30yds	VCB-CDO	5 levels R & G

C4

3-12x40 OPSL29

1" (25.4mm) Tube | Fully Multi-coated | Objective Lens Focus

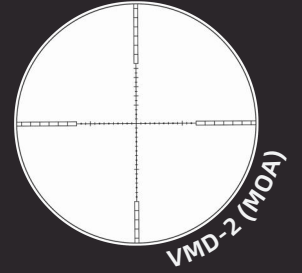

X4

1-4x20 OPSL18 | OPSL21

1" (25.4mm) Tube | Fully Multi-coated

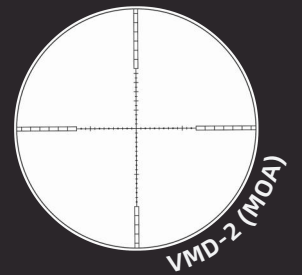

PRODUCT SPECS

SKU	Magnification	Objective Lens Dia	Exit Pupil (mm)	F.O.V (ft @100yds)	Eye Relief (mm / in)	Length (mm / in)	Weight (net)(g / oz)	Tube	Elevation Range	Windage Range	Click Value	Parallax Adjustment	Reticle	Illumination
OPSL18 <small>SFP</small>	1-4x	20mm	20.0-5.0	68.0-23.8	112-94 / 4.4-3.7	235 / 9.3	300 / 10.6	1" 25.4mm	180MOA	180MOA	1/2MOA	50yds	VMD-2	N/A
OPSL21 <small>SFP</small>							320 / 11.3							5 levels R & G
OPSL29 <small>SFP</small>	3-12x	40mm	13.3-3.3	35.0-11.6	100 / 4.0	332 / 13.0	510 / 18.0		60MOA	60MOA	1/4MOA	10yds to ∞		N/A





SRD RDSL27 | 1x20
3 MOA Dot Size
11 Levels **R**

Quick Release Picatinny Mount
& Low Weaver Mount



T4 RDSL17 | 1x30
3 MOA Dot Size
11 Levels **R**

Riser & Low Picatinny Mount



T4 RDSL29 | 1x28
30 mm Tube
4 MOA Dot Size
5 Levels **G & R**

Cantilever Picatinny Mount

PRODUCT SPECS

SKU	Reticle	Lens Dia	Eye Relief	Length (mm / in)	Weight (net) (g / oz)	Elevation Range	Windage Range	Click Value	Finish	Dot Intensity	Battery Type
RDSL27		20mm		76 / 3.0	195 / 7.7	>45MOA	>45MOA		Graphite		
RDSL28	3MOA		Free					1MOA		11 levels R	CR2032
RDSL17		22mm		69 / 2.7	123 / 4.3	100MOA	100MOA		Black Matte		
RDSL29	4MOA	30mm		125 / 4.9	200 / 7.1	80MOA	80MOA			5 levels T & G	



V2

RDSL01 | 1x18

3 MOA Dot Size

4 Levels **R**

20mm In Weaver Mount

V3

RDSL16 | 1x17x22

3.5 MOA Dot Size

6 Levels **R**

Switch On Side

RDSL18 | 1x17x22

3.5 MOA Dot Size

6 Levels **R**

Switch On Side

RDSL25 | 1x17x26

3.5 MOA Dot Size

6 Levels **R**

Switch On Side

Available In Weaver Mount Available In Dovetail Mount Available In Weaver Mount



T1

RDSL06 | 1x30

5 MOA Dot Size

5 Levels **G & R**

Weaver Mount

T1

RDSL05 | 1x35

5 MOA Dot Size

5 Levels **G & R**

Available In Weaver & Dovetail Mount

SRD

RDSL32 | 1x16x20

Made of 7075

20k Runtime

Without Weaver Mount

Auto Light Sense Without Switch

PRODUCT SPECS

SKU	Dot Size	Lens Dia	Eye Relief	Length (mm / in)	Weight (net) (g / oz)	Elevation Range	Windage Range	Click Value	Footprint Mount Type	Dot Intensity	Battery Type		
RDSL32 <small>new</small>	3MOA	16x20mm	Free	41 / 1.6	47 / 1.65	100MOA	100MOA	1MOA	MGT™	Auto Light Sense	CR2032		
RDSL33 <small>new</small>	3MOA	20x25mm		45 / 1.7	57 / 2.0				MOJ™				
RDSL01	3MOA	18x22.5mm	Free	51 / 2.0	57 / 2.0	60MOA	60MOA	1MOA	TEK™	5 levels R & G	CR2032		
RDSL05	5MOA	35mm		110 / 4.3	160 / 5.6	80MOA	80MOA		Weaver Mount				
RDSL06	3MOA	30mm		116 / 4.6	137 / 4.8	60MOA	60MOA		TEK™			11 levels R	
RDSL16	3.5MOA	17x22mm	Free	46 / 1.8	53 / 1.9	80MOA	80MOA	1MOA	TEK™	6 levels R	CR2032		
RDSL25	4MOA	17x26mm			53 / 1.9				80MOA			80MOA	MOJ™
RDSL18	3.5MOA	17x22mm			70 / 1.9				TEK™				



Z1 RDSL15 | 1x23x34

Multi-Reticle

5 Levels **G** & **R**

Weaver Mount

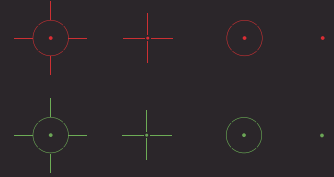

Z3 RDSL03 | 1x22x33

Multi-Reticle

Stepless **G** & **R**

Weaver Mount

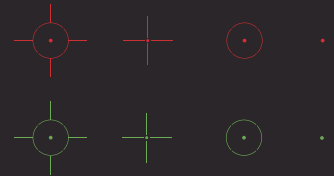

Z4 RDSL26 | 1x23x34

Multi-Reticle

5 Levels **G** & **R**

Quick Release Picatinny Mount

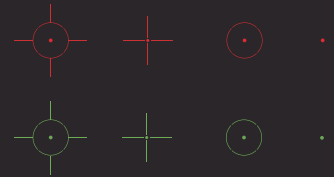

PRODUCT SPECS

SKU	Reticle	Lens Dia	Eye Relief	Length (mm / in)	Weight (net) (g / oz)	Elevation Range	Windage Range	Click Value	Finish	Dot Intensity	Battery Type
RDSL15	Four Reticles	23x34mm	Free	80 / 3.1	115 / 4.0	40MOA	40MOA	1MOA	Black matte	5 levels R & G	CR2032
RDSL20										Stepless R & G	
RDSL03										5 levels R & G	
RDSL26										5 levels R & G	

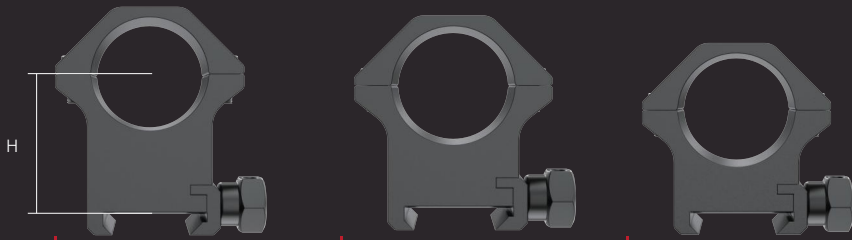

VIMW-03

H:30.5mm / 1.2in

VIMW-02

H:25.4mm / 1in

VIMW-01

H:22.5mm / 0.9in

25.4mm (1")
Weaver Rings

25.4mm (1")
Dovetail Rings

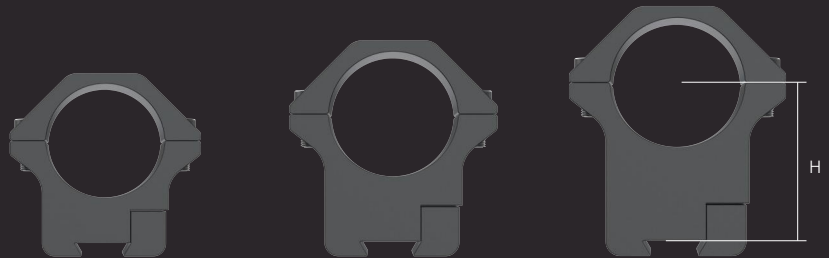

VIMD-01

H:22.5mm / 0.9in

VIMD-02

H:25.4mm / 1in

VIMD-03

H:33.4mm / 1.3in

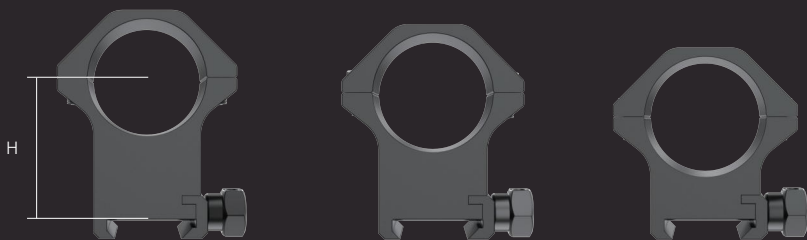

VIMW-13

H:36mm / 1.4in

VIMW-12

H:32mm / 1.25in

VIMW-11

H:25.4mm / 1in

30mm
Weaver Rings

30mm
Dovetail Rings

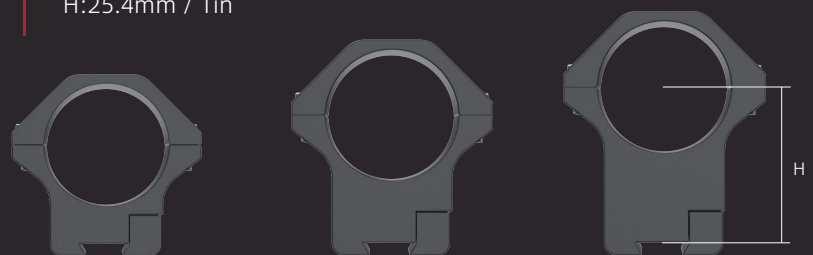

VIMD-11

H:27mm / 1.1in

VIMD-12

H:30mm / 1.2in

VIMD-13

H:36mm / 1.4in



BOSL01 | 8x42

BOSL02 | 10x42

Multi-Coated Lens
 Roof Prism, Coated Prism
 Center Focus

BINOCULAR

SKU	Magnification	Lens Dia	Type of Prism	Exit Pupil	Field of View	Size	Weight
BOSL01	8X	42mm	BAK7	5.2	6.3°	158x128.6x54mm	660g / 23.2
BOSL02	10X			4.0	5.8°	150x128.6x54mm	636g / 22.4



SSSL01 | 15-45x50

SSSL02 | 20-60x70

BAK7 Prism
 Center Focus
 Fully-Multi Coated
 Compact Lightweight

SPOTTING SCOPE

SKU	Magnification	Lens Dia	Type of Prism	Exit Pupil	Field of View	Weight
SSSL01	15-45X	50mm	BAK7 prism	3.4 - 1.15	2.6-1.26°	521g / 18.38oz
SSSL02	20-60X	70mm		3.55-1.2	2.45-1.26°	664g / 23.4oz



RFSL01 | 6x21

6-800 Yards Range
 Compact Size
 0.3s Responded Time
 Angle & Height Ranging

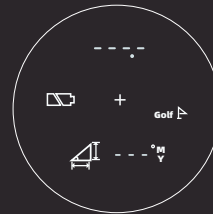

RANGE FINDER

SKU	Magnification	Lens Dia	Optical Structure	Ranging Distance	Angle Range	Field of view	Size	Weight
RFSL01	6X	21mm	Fully coated	116 / 4.6	- 70 to 70 degree	6°	98.5x77x37mm	125g / 4.4oz

SCOPE COLLIMATOR INSTRUMENT



Various Focal Length
 Red Dot & Optics
 25, 50 or 100 Yards

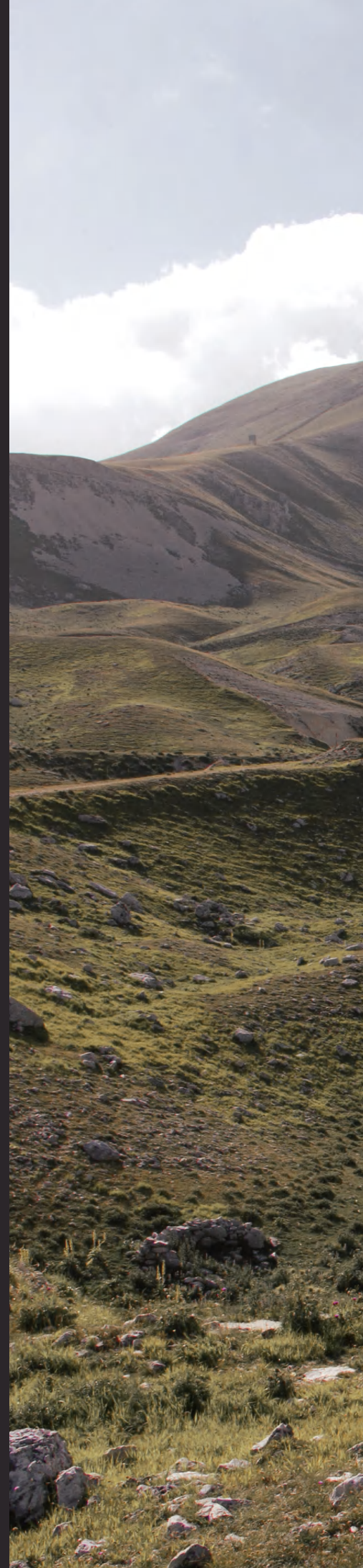





GUNPANY

Established In 2020 Is a Brand That Mainly Deals With The Products For Gun Cleaning, Maintenance, Installation And Supplementary

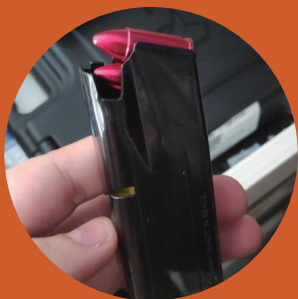

SNAP CAPS

A snap cap is a device that is shaped like a standard firearms cartridge but contains no primer, propellant, or projectile.

It serves the same function as a dummy round but is different in that a dummy is usually made from a real cartridge with its propellant and primer removed (still has the projectile and the casing).

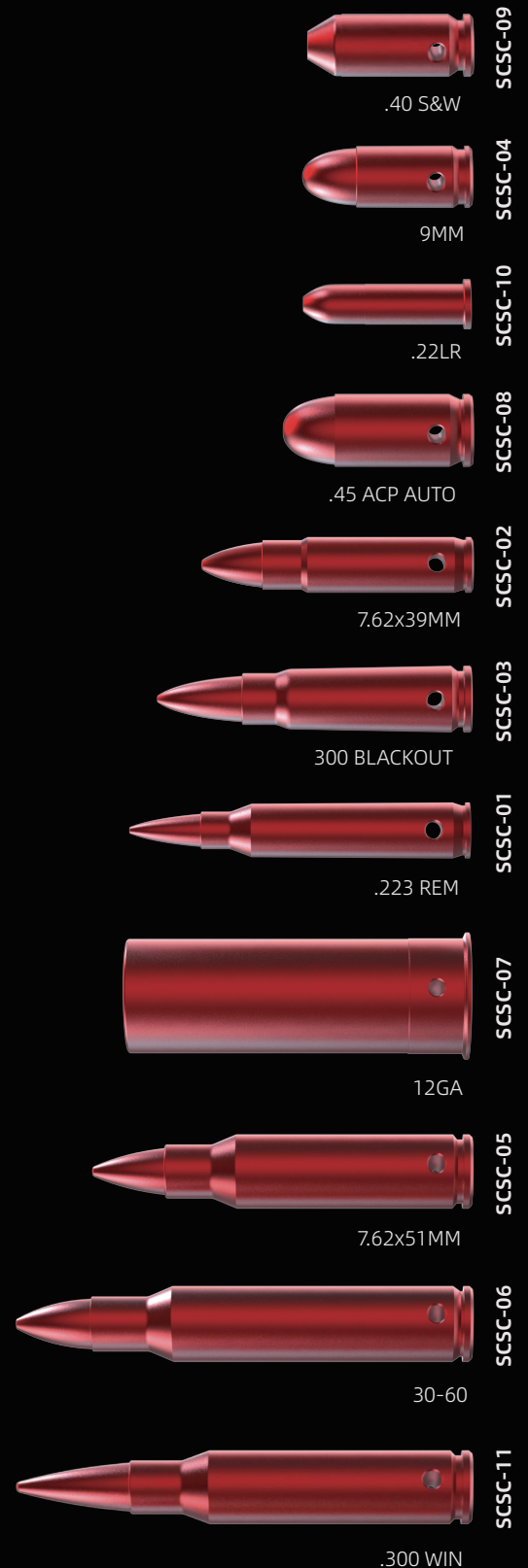

BENCH MAT



SCBM-01



SCBM-02



SCBM-04



SCBM-03

OTHERS

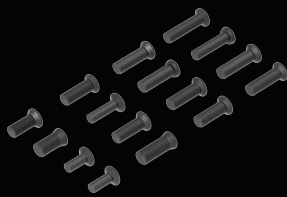

Screw Package *New*
SCTK-07



Plastic Wrench-Ranging *New*
SCTK-06



Torque Screwdriver *New*
SCTK-04



Plastic Wrench
SCOT-61



Stainless Steel
Torx Type: T10 and T6
Two Flat Screwdrivers
SCTK-05



16 Pcs Boresighter Kit
GPBS-01



Bore Barrel Cleaning Rope
SCOT-46



Compact Gun Trigger Lock
SCOT-35



Bolt Action Silicon Cover
SCOT-51

AND MORE.....

CLEANING KIT



○ 12GA Shotgun
SCCK-08

○ 410 Shotgun
SCCK-09

○ Airgun .177 & .22
SCCK-10

MORE COLORS FOR YOU TO CHOOSE FROM



27 Pcs Universal Gun Cleaning Kit
SCCK-01



19 Pcs Cleaning Kit
GPGC-A19B



AR15 / M4 Cleaning Kit Pouch
GPGC-A15P



3 Brushes 2 Picks
GPGC-3B2P

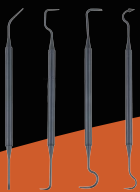

4 Double Side Picks
GPKK-4P



- Brass Rod
- Universal Handle
- Utility Cleaning Brush
- 6 Nylon Jags
- 2 Nylon Slotted-tips
- 3 Brass Adaptors
- Plastic Muzzle Guard
- 1 Pack of Cleaning Patches
- Bronze Brush
- Cotton Mop

62 Pcs Universal Gun Cleaning Kit | SCCK-20

BORE BARREL CLEANING ROPE



.223 / 5.56mm
SCCK-02



.308 / 7.62mm
SCCK-03



9mm
SCCK-04



12GA
SCCK-05



.45
SCCK-06



.270 / 7mm
SCCK-07



.22 LR
GPCL-22LR



.338
GPCL-338



12.7mm
GPCL-127



.408
GPCL-408



9mm Pistol
GPCL-P9

AND MORE.....



Rokstad

Mainly engaged in the brand of monopods, bipods, tripods, gun stocks and other auxiliary products



SHOOTING SYSTEM



BBS V Mount Tripod

RSGR-07 / RSGR-08



80cm 31" Folded | 188cm 74" Extended
Ball Bearing Socket Connector | QD Level Lock



KNE Shooting Stick

SCOT-12

1 M Height at Open Status | Kneeling Position
0.45 Meter Folded | 6063-T6 Alloy Aluminum



MAG V Mount Monopod

RSGR-01

84cm 33" Folded | 181cm 71" Extended
Magnetic QD Connector | Twist Lock



LIT V Mount Bipod

RSGR-05

65cm 25" Folded | 120cm 47" Extended
Twist Lock | 6063-T6 Alloy Aluminum



ELP V Mount Tripod

RSGR-06

20cm 7.9" Folded | 26cm 11.4" Rised
Twist Lock | 6063-T6 Alloy Aluminum



TPM Shooting Gun Rest

RSGR-12 (RSGR-07 & 08 Compatible)

V Mounts Made of Plastic & None-Slip Rubber
6061-T6 Aluminum Platform | 1/4"-20 Thread Bushing



Shooting Rifle Rest Tripod Saddle Mount

RSGR-14 (RSGR-07 & 08 Compatible)

Grips And Hold Rifle In Wide 35-65mm (1.4-2.5")
Made from Aluminum Alloy | 1/4"-20 Thread Bushing

BINOCULAR REST



Binocular Rest Tray Mount BLK / WOD

RSBR-01 / RSBR-02



Made of Plastic and Nylon Polymer | None-Slip Base
Elastic Rubber Strap | 1/4"-20 Thread Bushing Fits
Nearly All Photographic Tripods



New Binocular Adapter for Tripod Mount

RSBR-03

1/4"-20 Thread Bushing | Compatible w/ ARCA
Aluminum Alloy

SHOOTING BIPOD



6-7" / 9-10.6" Universal

SCBPW-01 / SCBPW-02

Panning | Weaver Mount Base | Rubber Feet, Spring Eject | with Barral Mount Adapter



6-9" Swivel Spring Retractable

SCBPS-04

80cm 31" Folded | 188cm 74" Extended
Ball Bearing Socket Connector | QD Level Lock



9-13.5" Swivel Spring Retractable

SCBPS-05

9-13.5" Style | Sling Stud Connect with Weaver Mount Adapter



15-26" Swivel Spring Retractable

SCBPS-06

815-26" Style | 6 Levels Retractable Legs
Sling Stud Connect | with Weaver Mount Adapter



6-9" Spring Retractable

SCBPB-01

6-9" Style | Sling Stud Connect with Weaver Mount Adapter



9-13.5" Spring Retractable

SCBPB-02

9-13.5" Style | 6 Levels Retractable Legs
Sling Stud Connect | with Weaver Mount Adapter



Carbon Fiber 6-9" Swivel Spring Retractable

RSCFS-06

6-9" Height | Legs Made of Carbon Fiber
Swivel Sling Stud Clamp with Picatinny Mount Adapter



Carbon Fiber 9-13.5" Swivel Spring Retractable

RSCFS-09

9-13.5" Style | Sling Stud Connection
Legs Made of Carbon Fiber | 6 Levels Retractable Legs
with Picatinny Mount Adapter



Carbon Fiber 6-9" Spring Retractable

RSCFP-06

6-9" Style | Sling Stud Connect | Legs Made
6 Levels Retractable Legs | Spring Loaded
with Weaver Mount Adapter



Carbon Fiber 9-13.5" Spring Retractable

RSCFP-09

9-13.5" Style | Legs Made of Carbon Fiber
Sling Stud Connect | 6 Levels Retractable Legs
Spring Loaded, with Weaver Mount Adapter

CARBON FIBER TRIPOD



New Tabletop Tripod

RSCF-T01

Tube Dia 22.5mm | 3-Sections | Extended to 38cm 15in
Folded to 25cm 9.8in | Max Load 18kg 40lbs
UNC 3/8" with 1/4" Adapter



New Ground Tripod

RSCF-T02

Tube Dia 34mm | 4-Sections | Extended to 170cm 67in
Folded to 64cm 25in | Max Load 35kg 77lbs
UNC 3/8" with 1/4" Adapter

RIFLE HEAD



New 38mm Ball Head

RSRH-01

Tension Control | Ball Lock
Dual Mounting: Picatinny & ARCA-Swiss
with QR Plate 1/4" & 3/8" Adapter
Max 20kg 44lbs | Fit RSCF-T01



New 56mm Ball Head

RSRH-02

Tension Control | Ball Lock
Dual Mounting: Picatinny & ARCA-Swiss
with QR Plate 1/4" & 3/8" Adapter
Max 30kg 66lbs | Fit RSCF-T01

DUAL OBSERVATION RAILS

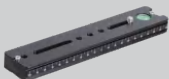

New Dual Observation Rail

RSOR-01

Two Mounting Systems | Full Metal | To Mount Optics & Other Devices
200mm 7.9in Length | UNC 3/8" with 1/4" Option





BORE SIGHT

RED LASER | MADE OF BRASS



AND MORE.....

LASER SIGHT

SUBCOMPACT | SMART-SENSOR | IPX4 WETER RESISTANT

VRRL-P01

Compact Red Laser



VRGL-P01

Compact Green Laser



VRRL-P03

Red Laser



VRGL-P03

Green Laser



SCRL-07

IR Red Laser Combo



SCGL-10

IR Green Laser Combo



SKU	Power	Wavelength	Weight	Length	Battery
VRRL-P01	≤5mW Class IIIa	630-650nM	33g / 1.2oz	43.5mm / 1.7 inch	Build-in Rechargeable Lithium
VRRL-P02					
VRGL-P01		510-532nM	52g / 1.8oz	61mm / 2.4in	
VRGL-P02					
VRRL-P03		630-650nM	255g / 9.0oz	99mm / 3.9in	
VRRL-P04					
VRGL-P03		510-532nM	CR123		
VRGL-P04					
SCGL-07	635-660nM IR 830-850nM	255g / 9.0oz	99mm / 3.9in		
SCGL-10	510-532nM IR 830-850nM				

PISTOL FLASHLIGHT

SMALL BODY, GREAT POWER IS VAIDE FLASHLIGHT!

PISTOL FLASHLIGHT

Compact Red Laser Flashlight

VAPLL-R01

500 Lumens

Strobe Feature

21mm Weaver Mount

3 Levels Brightness White LED

Smart-Sense Momentary on/off Switch



Compact Green Laser Flashlight
VAPLL-G01



Red Laser Flashlight
VAPLL-R02



Green Laser Flashlight
VAPLL-G02

SUBCOMPACT PISTOL FLASHLIGHT

VAPL-01

Compact Pistol Flashlight



VAPL-03

Pistol Flashlight



SKU	Brightness Lumen	Brightness Mode	Dimensions	Laser Wavelength	Battery Runtime	
VAPLL-R01	500 lumens High 200 lumens Medium 40 lumens Low	High Medium Low Strobe	Length : 55mm / 2.17in	630-660nm <5mW class 3A	Combo: 15min (high) > 20min (medium) > 1h (low)	
VAPLL-G01			Width: 28mm / 1.10in	510-550nm <5mW class 3A		
VAPLL-R02			Height: 38mm / 1.50in	630-660nm <5mW class 3A	Combo: 35min (high) > 45min (medium) > 2h (low)	
VAPLL-G02			Length: 65mm / 2.56in	510-550nm <5mW class 3A		
VAPL-01		Constant / Strobe	Constant / Strobe	Length: 51mm / 1.90in	/	10Min (high) 35Min (medium) 4.5 hours (low)
VAPL-02				Width: 28mm / 1.10in		
VAPL-03				Height: 33mm / 1.30in		
VAPL-04				Length: 63mm / 2.5in		45Min (high) 55Min (medium) 3 hours (low)
			Width: 28mm / 1.1in			
			Height: 27mm / 1.1in			



X-ACCU

Offers scope accessories that enhance precision, stability, and reliability
empowering shooters to achieve their best performance

CONTINENTAL
6-48x56 ED

UP
5
0
UP
9.5
4.5



30 MOA

B699121



MIGHTY SCOPE RINGS (30MM)

Picatinny Rings | 1" Profile

XASR-3001 | Center Height 1.0" (25.4mm)

Picatinny Rings | 1.25" Profile

XASR-3002 | Center Height 1.25" (32mm)

Picatinny Rings | 1.4" Profile

XASR-3003 | Center Height 1.4" (35mm)



30mm

Dovetail Rings

Center Height 1.25" (32mm) / 1.5" (38mm)
XASR-3005 / XASR-3006



30mm

Cantilever Weaver Rings

Center Height 1.25" (32mm)
XASR-3016



30mm

Cantilever Dovetail Rings

Center Height 1.25" (32mm)
XASR-3017



30mm

Dovetail Mount

Center Height 1.1" (28mm)
XASR-3100



30mm

High Picatinny Mount

Center Height 1.4" (35mm)
XASR-3012 / XASR-3013



30mm

Medium Picatinny Mount

Center Height 1.2" (32mm)
XASR-3010 / XASR-3011



30mm

Mount Assembly Kit

XASR-A02 / XASR-A03

MIGHTY SCOPE RINGS (34MM)

Picatinny Rings | 1.1" Low Profile

SCTM-52 | Center Height 1.1" (28mm)

Picatinny Rings | 1.4" Low Profile

SCTM-53 | Center Height 1.4" (35mm)

Picatinny Rings | 1.6" Profile

SCTM-54 | Center Height 1.6" (40mm)



One Piece Medium Picatinny Mount

Center Height 1.4" (35mm)
SCTM-60 / SCTM-61



One Piece High Picatinny Mount

Center Height 1.6" (40mm)
SCTM-57 / SCTM-58



Mount Assembly Kit

XASR-A01



One Piece High Picatinny Mount

Center Height 1.6" (40mm)
XASR-3014 / XASR-3015

ELITE SCOPE RINGS

Picatinny Rings | 1" Profile

XASR-2501 | Center Height 1.0" (25.4mm)

Picatinny Rings | 1.25" Profile

XASR-2502 | Center Height 1.25" (32mm)

Picatinny Rings | 1.4" Profile

XASR-2503 | Center Height 1.4" (35mm)



Extended Picatinny AR Mount
XASR-3031 | Center Height 1.5" (38mm)



Extended Picatinny AR Mount
XASR-3032 | Center Height 1.5" (38mm)



Adjustable Extended Picatinny
XASR-3037 | Center Height 1.50" (38mm)



Extended Picatinny AR Mount
XASR-3035 / XASR-3036 | Center Height 1.5" (38mm)

ELITE ACD MOUNT



30mm One Piece Weaver Mount
SCACD-23



Universal Flat
SCACD-19



30mm One Piece Cosine Indicator
SCACD-24



Offset Bubble Weaver Mount
SCACD-20



30mm One Piece Dovetail Mount
SCACD-25



Offset Bubble Dovetail Mount
SCACD-21

New



30mm / 34mm

Turret Mark Reader
SCTR-01 / 02



40mm Offset Bubble
SCACD-12



30mm Offset Bubble GenII
SCACD-26



34mm Offset Bubble GenII
SCACD-27



30 / 25.4mm Offset Bubble With Top Rail
SCACD-07



Screw-in M4 Screw Holes
SCACD-22

ADJUSTABLE SCOPE RINGS



25.4mm 1"

Adjustable Picatinny Rings

XASR-2510 | Center Height 1.2-1.4" (30-36mm)



25.4mm 1"

Adjustable Dovetail Rings

XASR-2515 | Center Height 1.3-1.5" (33-36mm)



30mm

Adjustable Picatinny Rings

XASR-3040 | Center Height 1.25-1.5" (32-38mm)



30mm

Adjustable Dovetail Rings

XASR-3045 | Center Height 1.4-1.6" (35-41mm)



34mm

Adjustable Picatinny Rings

XASR-3050 | Center Height 1.4-1.6" (34.5-40.5mm)



34mm

Adjustable Dovetail Rings

XASR-3055 | Center Height 1.5-1.7" (37.5-43mm)



30mm

Adjustable Cantilever Weaver Rings

XASR-3060 | Center Height 1.4-1.6" (35-41mm)



30mm

Adjustable Cantilever Dovetail Rings

XASR-3065 | Center Height 1.4-1.6" (35-41mm)

SCOPE WEAVER RINGS



30mm

Weaver Rings | 0.8" Low Profile

SCTM-27

Weaver Rings | 1.0" Medium Profile

SCTM-22

Weaver Rings | 1.2" High Profile

SCTM-08

Weaver Rings | 1.4" Extreme High Profile

SCTM-65



25.4mm 1"

Weaver Rings | 1.0" Medium Profile

SCTM-37

Weaver Rings | 1.14" High Profile

SCTM-56

Weaver Rings | 1.25" Extreme High Profile

SCTM-64

SKU	Diameter	Width	Center Height	Weight(net)	Material
SCTM-65	30mm	16mm / 0.6in	35mm / 1.57in	137g / 4.8oz	6061-T6 Aluminum Alloy
SCTM-27			21mm / 0.83in	105g / 3.7oz	
SCTM-22			25.4mm / 1in	120g / 4.2oz	
SCTM-08			31mm / 1.2in	130g / 4.6oz	
SCTM-37	25.4mm / 1in	16mm / 0.6in	25.4mm / 1in	113g / 4.0oz	
SCTM-56			29mm / 1.14in	125g / 4.4oz	
SCTM-64			31.5mm / 1.25in		

STEEL SCOPE PICATINNY WEAVER RINGS



25.4mm 1"

Weaver Quick Release Rings | Low Profile

XASR-SQ01 | Center Height 0.75" (19mm)

Weaver Quick Release Rings | Medium Profile

XASR-SQ02 | Center Height 1.0" (25.4mm)

Weaver Quick Release Rings | High Profile

XASR-SQ03 | Center Height 1.25" (32mm)



30mm

Weaver Quick Release Rings | Extreme Low

XASR-SQ10 | Center Height 0.8" (20.3mm)

Weaver Quick Release Rings | Low Profile

XASR-SQ11 | Center Height 1.0" (25.4mm)

Weaver Quick Release Rings | Medium Profile

XASR-SQ12 | Center Height 1.25" (32mm)

Quick Release Weaver Rings | High Profile

XASR-SQ13 | Center Height 1.5" (38mm)

98K Turret Mount Ring

SCSR-07



30mm Flip to Side Picatinny Ring

SCSR-08



SKU(quick release)	Diameter	Width	Center Height	Weight (net)	SKU (standard)
XASR-SQ01	25.4mm / 1in	18mm / 0.7in	19mm / 0.75in	135g / 4.8oz	XASR-S01
XASR-SQ02			25.4mm / 1in	160g / 5.6oz	XASR-S02
XASR-SQ03			31.8mm / 1.25in	180g / 6.4oz	XASR-S03
XASR-SQ10	30mm	18mm / 0.7in	20.3mm / 0.8in	145g / 5.1oz	/
XASR-SQ11			25.4mm / 1in	160g / 5.6oz	XASR-S11
XASR-SQ12			31.8mm / 1.25in	175g / 6.2oz	XASR-S12
XASR-SQ13			38.1mm / 1.5in	205g / 7.2oz	XASR-S13
SCSR-07	26.5mm	22mm / 0.9in	41mm / 1.6in	320g / 11.3oz	/
SCSR-08	30mm	40mm / 1.6in	38mm / 1.5in	212mm / 7.5oz	/

TACTICAL PICATINNY MOUNT

30mm



Flip to Side Picatinny Ring

SCTM-17 | Center Height 1.4" (36mm)

30mm



One Piece Offset Picatinny Mount

SCTM-24A | Center Height 1.5" (38mm)

25.4mm 1"



One Piece Offset Picatinny Mount

SCTM-63 | Center Height 1.5" (38mm)

30mm



30mm Scope Tube Mount

SCTM-21 | Top rail length 1.8" (45mm)

30mm



20MOA Picatinny Mount

SCTM-39 | Center Height 1.25" (35mm)

30mm



One Piece Picatinny Mount

SCTM-36 | Center Height 1.25" (35mm)

30mm



One Piece Picatinny Mount TPR

SCTM-59 | Center Height 1.4" (36mm)

30mm



One Piece Offset Mount Ring XL

SCTM-24B | Center Height 1.5" (38mm)

OTHERS



**2" / 4" / 5"
Key Mod Rail Section**
SCRAAM-22 / 23 / 24



M-Model Rail Screws Kit
SCMLS



KeyMod Rail Screws Kit
SCKRS



**2" / 4" / 5"
M-Model Rail Section**
SCRAAM-52 / 53 / 54



**Dovetail to Weaver
Mount Rail Short**
SCRA-06B



**(S / M / L / XL)
Riflescope Coat Cover**
SCOT-44-1 / 44-2 / 44-3 / 44-4

STEEL RAILS AND MOUNTS



T3 Picatinny Steel Rail
SCTIK-01



R700 Steel Rail Bases
SCRA-69



98K Steel Rail Mount
SCRA-70



**0MOA / 20MOA
R700 Steel Rail Long**
SCRA-62 / 63

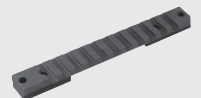

**0MOA / 20MOA
R700 Steel Rail Short**
SCRA-64 / 65



Swiss K31 Dovetail Mount
VDMS-10



**Lee Enfield 303
Picatinny Rail Mount**
VDMS-11



**Mosin-Nagant
91/30 PEM**
VDMS-12



**Mosin-Nagant &
SVT Mount**
SCRA-61



Lee Enfield Scope Mount
SCRA-66





Bright your night

NIGHT VISION

Digital Day & Night Vision



OWNV-02

5x32 DIGITAL DAY & NIGHT VISION MONOCULAR

Max 200-Meter Range in Dark
Digital 3x Zoom | Ease for Use
With IR Illumination
Photo and Video Recording
Compact Portable Palm-in-Hand Size



OWNV-10

1x18 DIGITAL DAY & NIGHT HELMET HEAD MOUNTED HD

Max 200-Meter Range in Dark
Digital 3x Zoom | Black&White&Green
With IR Light
Focus Adjustment
WIFI | Video Recording



OWNVS-03

8x50mm HD NIGHT VISION SCOPE

Max 1000-Meter Range in Dark
IP68
Digital 8x Zoom
With IR Light
WIFI | Video Recording



HELMET FLIP-UP MOUNT KIT

OWNV-MT10



INTRODUCTION

MCC10 follows the design of traditional optical equipment. It is a small, lightweight, simple operation with a wide range of application scenarios for infrared handheld thermal imaging monoculars.

MCC10 Thermal scope has clear imaging and comfortable observation, suitable for medium distance and short-distance observation, It is an ideal equipment for outdoor night vision.

APPLICATION

- Outdoor
- Search & Rescue
- Wild Adventure
- Personal Security
- Law Enforcement
- Livestock Breeding

FEATURES AND BENEFITS

- Boot up in 2 seconds and ready to use.
- High-sensitivity self-developed infrared detector to accurately detect targets.
- Built-in laser indicator to locate the target easily.
- 1280x960 high resolution LCOS display.
- Screen to provide a comfortable observation.
- PIP mode to highlight target clearly.
- Connect APP via WIFI to share anytime.
- Support 8 hours super long operation time.
- IP66 encapsulation, rugged and durable.

Handheld Thermal Imaging Monocular

	VEOT-MC01 MCC10	VEOT-MC02 MCX10	VEOT-MC03 MCX20	VEOT-MC04 MCX30
Detector type	VOx			
Detector resolution	256X192, 12 μm		400X300, 12 μm	
NETD	≤50mk		≤40mk	
Frame rate	50 Hz			
Focal length	10 mm; F1.0	19 mm; F1.0	25 mm; F1.1	35 mm; F1.0
Focus	Electric		Manual	
Field of view	17.1°x13.0°	13.6°x10.3°	10.4°x7.9°	7.5°x5.6°
Optical zoom	1.5X	1.9X	2.4X	3.4X
Digital zoom	1x, 2x	1x, 2x and 4x		
Battery type	Single, replaceable 18650 battery			
Battery life	≥ 8 hours		≥ 7 hours	
USB	Type C (USB 2.0 standard), supporting analog video and power supply			
Display type	0.4" FLCOS			
Resolution	1280x960			
Eyepiece	Monocular, exit pupil distance ≥12 mm, diopter adjustment: -4 to +2			
Eyepiece zoom	13.8x			
PIP	Upper left, upper middle, upper right, closed			
Color palettes	Black hot, white hot, red hot, iron hot, blue hot			
Hot spot tracking	Available			
Language settings	Chinese or English			
Storage temperature range	-30 °C to 60 °C			
Shock	30g at 11 ms half sine pulse (as per IEC60068 -2-27)			
Vibration	10 Hz~150 Hz~10 Hz 0.15 mm (as per IEC60068 -2-6)			
Drop	1m			
Encapsulation	IP66			
Weight	≤ 280g		≤ 350g	
Size (L × W × H)	130x40x70 mm		150x40x70 mm	



INTRODUCTION

RSM50 thermal imaging riflescope retains the appearance of a traditional daylight scope and perfectly integrates latest premium thermal imaging technology.

The design of this scope accommodates long-term operating habits of hunters. RSM50 adopts high-sensitivity thermal detector with three different lens options of 25mm,35mm,50mm, and its 10 sets of zero calibration configuration make it convenient to switch between different instruments.

APPLICATION

○ Outdoor Observing

FEATURES AND BENEFITS

- HD OLED display, with 1x~8x smooth zoom, provides a comfortable visual experience.
 - 10 sets of zero calibration configurations can be saved. No need to recalibrate for different instruments.
 - Mounts on Standard 30 mm Scope Rings.
 - 10 kinds of reticles, 6 kinds of reticle colors, 10 grades of reticle brightness, for your selection.
 - Support photo and video, record wonderful moments at any time, easy to share.
 - 10 hours super long duration time.
- Law Enforcement

Thermal Riflescope

	VEOT-RS01 RSM450	VEOT-RS02 RSM420	VEOT-RS03 RSM43	VEOT-RS04 RSX20	VEOT-RS05 RSX30	VEOT-RS06 RSX50
Detector type	400x300@17μm, VOx			640x480@12μm, VOx		
Spectral	8μm ~ 14μm					
NETD	≤50mk					
Focal Length	25mm	35mm	50mm	25mm	35mm	50mm
FOV	15.49°x11.65°	11.1°x8.33°	7.78 °x5.84°	17.46°x13.14°	12.52°x9.41°	8.78 °x6.59 °
Display Screen	Full-color 0.39'OLED screen , 1024x768					
Eyepiece	Pupil distance of eyepiece 48mm , Eyepiece magnification 14x					
Digital Zoom	1x~4x (Smooth zoom)			1x~8x (Smooth zoom)		
Internal Storage	16G					
Magnification	1.6x~6.4x	2.3x~9.2x	3.2x~12.8x	1.4x~11.2x	2.0x~16.0x	2.8x~22.4x
Frame Rate	50Hz					
Scene Modes	Enhance, highlight, natural					
Color Palettes	White hot, black hot, customized red hot, green hot, iron red, blue heat					
Wi-Fi/APP	Connect App (IOS & Android) via WIFI to realize remote control, live image and video transmission					
Compensation Modes	Scene compensation, shutter compensation, automatic compensation					
Zero Calibration	50m / 100m / 200m / 300m / 500m					
Gun Type Selection	10 sets of zero calibration configurations can be saved, no need to recalibrate for different instrument					
Reticle	10 reticle styles, 6 colors, 10 levels of brightness					
Others	Photo taking, video recording, hotspot tracking, stadia metric rangefinder					
Battery Type	1x internal Battery + 1x external battery, rechargeable, change the external battery without power cut off					
Battery Operating Time	Battery continuous working time ≥ 10hrs					
USB	Type-C, It can supply external power and charge, and can read the data of memory card					
Operating Temperature	-30 °C ~ 50 °C (External power supply is required below -20°C)					
Storage Temperature	-45°C ~ 70°C					
Shock	500g / 1ms					
Vibration	10Hz ~ 150Hz ~ 10Hz 0.15mm IEC60068 -2-6					
IP level	IP67					
Weight	930g	940g	950g	980g	980g	990g
Dimensions	367x107x69mm	377x107x69mm	367x107x69mm	367x107x69mm	377x107x69mm	377x107x69mm



INTRODUCTION

The 35mm thermal module is the center of the system with its 35mm lens system and 384x288px. The matrices are built using 12-um technology, which makes it possible to obtain a greater optical magnification without increasing the external dimensions of the device.

Based on VOx (vanadium oxide) technologies, with high thermal sensitivity, the 35 NETD performance ensures the detection of small temperature changes and excellent performance in harsh conditions. This increases the detection range of heat-contrast objects and enables substrate visibility.

FEATURES AND BENEFITS

- You will be able to see the target even in extreme surveillance conditions such as snow, rain, fog/high humidity and at high ambient temperatures (from 30 degrees Celsius).
- Frame refresh rate - 50 Hz.
- 4 different image display color palettes (hot white, hot red, hot black and hot iron).
- 3 sensor calibration modes — automatic, semi-automatic, manual.
- The sight has a compartment for 4 CR123A batteries or batteries of the same size. The device can operate from any number of installed batteries within the available 4 places, even from one battery.

Thermal Image Scope 3-IN-1: Riflescope/Monocular + Clip on

	VEOT-AD01 CO35 1x35mm	VEOT-AD02 CO50 1x50mm
Image Sensor	Uncooled Focal Plane Arrays	
Resolution	384x288	640x512
NETD	Less than 35 mK (25 °C, F#=1.0)	
Frame Rate	50 Hz	
Focal Length	35 mm	
Pixel Interval	12 μm	
Response Waveband	8 μm to 14 μm	
Detection Distance	1800m	2600m
Field of View	7.5°x 5.7°	8.78 °x 7.03 °
Min. Focusing Distance	3.5m	5m
Aperture	F1.0	
Magnification	1x	
Display	1024x768, 0.39 inch, OLED	
Palettes	Black hot, white hot, red hot, fusion	
Eye Relief	10mm	
Storage Capacity	Built-in EMMC (64 GB)	
Picture-in-Picture	Yes	
Hot Spot	Yes	
Battery Type	Applicable type: CR123A, RCR123A	
Battery Operating Time	8 h (25 °C, with hotspot off)	6.5 h (25 °C, with hotspot off)
Type-C Power Bank	5 VDC, 2 A Supports external power supply	
Work Temperature/Humidity	-20 °C to 55 °C (-4 °F to 131°F)	
Protection Level	IP67	
Vibration & Shock	750 g / 1 ms	
Detection	179x68x63mm	192x76x69mm
Weight	532g without eyepiece and batteries	583g without eyepiece and batteries
Port	Type-C	

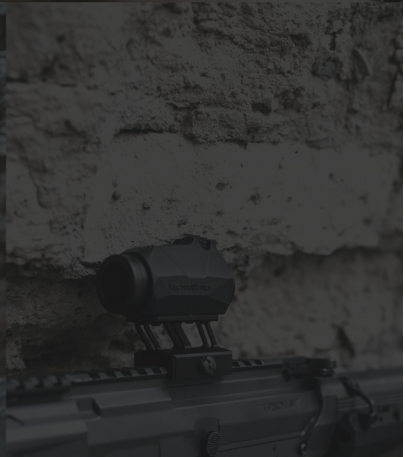

You Tube



WWW.VECTOROPTICS.COM





VECTOROPTICS[®].com